



AOVET战略合作伙伴



CATALOG  
2023-2024

# Contents

## Veterinary Orthopedic Instruments

General Orthopedic Instruments	1-42
Bone Models And Pre-Operative Planing	43-49

## Veterinary Implants

Bone Screws	50-69
Bone Plates	70-118
Wires and Pins	119-122
Interlocking Nail	123-124
External Fxiation	125-132
Titanium Elastic Nailing	133-134
Headless Compression Screw System	135-136
Universal Aiming Device Set	137
Bone Anchors	138-144
Spinal Surgery Instruments	145-157
Power Tools	158-163

## Soft Tissue Instruments

Crile And Allis	164
Scissors	165-166
Needle Holders	167
Tissue Forceps	168
Towel Forceps	169-170
Mouth Openers	171
Retractors	172
Soft Tissues Instruments Set	173-174

## Dental Instruments

Dental Scalers And Probes	175
Dental Extraction Forceps	176
Dental Elevators	177
Small Animal Dental Instruments Set	178
Rabbit And Rodent Dental Instruments	179-181
Rodent Dental Instrument Set	182

## Ophthalmology Instruments

Non-magnetic Stainless Steel Ophthalmology Instruments	181-185
Titannium Ophthalmology Instruments	186-187
Ophthalmology Instruments Set	188-189

## Sterlization And Cleaning

Sterlization Cases And Trays	190-191
------------------------------	---------

## Anaesthesia

Anaesthesia	192-194
-------------	---------

## Absorbable Sutures

PGA Absorbable Sutures	195
------------------------	-----

# Distraction And Reduction Tool For Fractures And Osteotomy

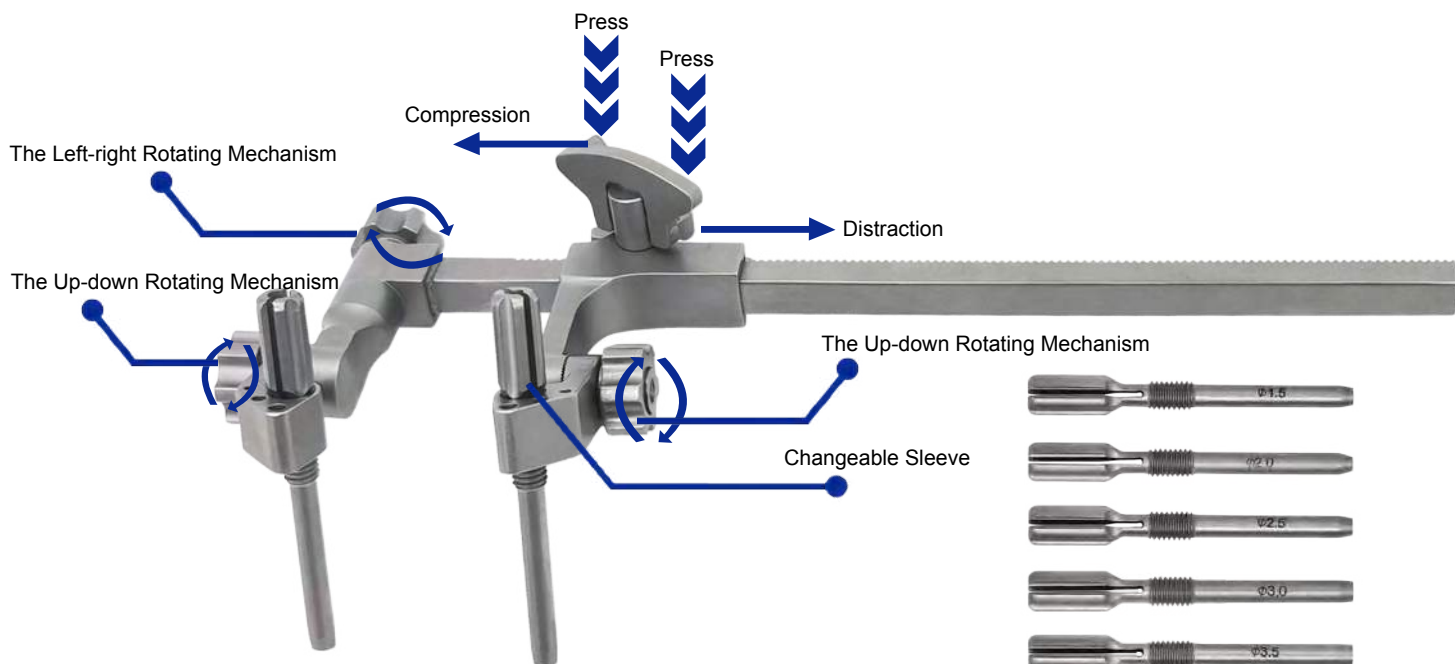

For Corrective Osteotomies



For Fracture distraction and reduction

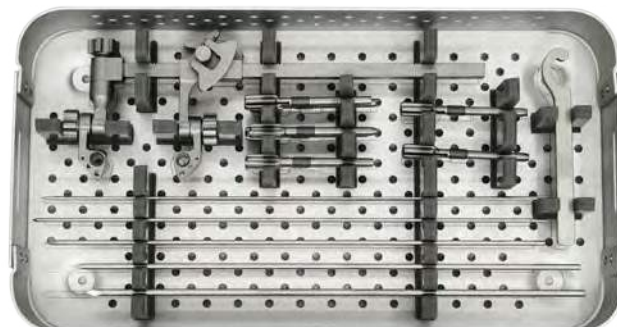

Code	Products Name/Specification	Quantity	U.P.\$
PS1525	Kirschner Wire Single Head Sharp $\Phi$ 1.5X250mm	2	1.3
PS2025	Kirschner Wire Single Head Sharp $\Phi$ 2.0X250mm	2	1.6
PS2525	Kirschner Wire Single Head Sharp $\Phi$ 2.5X250mm	2	1.6
PS3025	Kirschner Wire Single Head Sharp $\Phi$ 3.0X250mm	2	1.9
PS3525	Kirschner Wire Single Head Sharp $\Phi$ 3.5X250mm	2	2.3
PS4025	Kirschner Wire Single Head Sharp $\Phi$ 4.0X250mm	2	2.9
DR0015	Pin Sleeve $\Phi$ 1.5	2	32.3
DR0020	Pin Sleeve $\Phi$ 2.0	2	32.3
DR0025	Pin Sleeve $\Phi$ 2.5	2	32.3
DR0030	Pin Sleeve $\Phi$ 3.0	2	32.3
DR0035	Pin Sleeve $\Phi$ 3.5	2	32.3
DR0002	Wrench	1	32.3
DR0001	Distraction And Reduction Main Body	1	621.9
DR0000	Sterilization Box For Distraction And Reduction Tool	1	206.5

U.P.\$ 1206.9

# Micrometric Locking Forceps



**Technical Advantages :**

- Non gap locking system
- Friction locking , easy release from the full load
- With smooth,low opening and closing force
- More light weight Semi-Hollow Design
- Jaws are made from hardened stainless steel
- With variety of functions, aiming and measuring

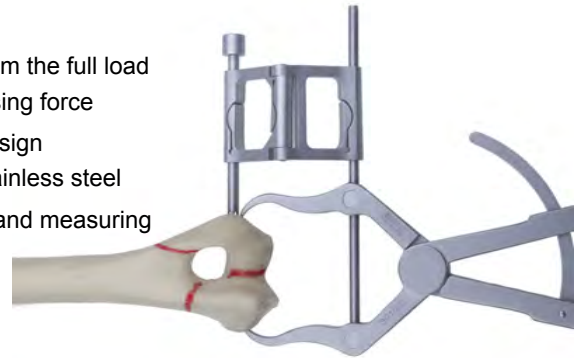

## Pointed Reduction Forceps

Veterinary Use Only



Unit mm

Code	Products Name	Specification	L	U.P.\$
301001	Pointed Reduction Forceps	Small 30mm	140mm	206.5
301002	Pointed Reduction Forceps	Large 62mm	176mm	190.3

## Plate Holding Forceps

Veterinary Use Only



Code	Products Name	Specification	L	U.P.\$
301003	Plate Holding Forceps	34mm	162mm	206.5



Unit mm

## Condyle Reduction Forceps

Veterinary Use Only



Code	Products Name	Specification	L	U.P.\$
301004	Condyle Reduction Forceps	64mm	175mm	222.6

Unit mm

## Mini Holding Forceps

Veterinary Use Only



Code	Products Name	Specification	L	U.P.\$
301005	Mini Holding Forceps	20mm	139mm	174.2

Unit mm

## Pointed Reduction Forceps With Aiming Device

Veterinary Use Only



Unit mm

Code	Products Name	Specification	L	U.P.\$
301006	Aiming Forceps	Open Range 30mm	144mm	368
301106	Aiming Device	Small		
301101	Drill Sleeve	1.1mm		
301102	Drill Sleeve	1.5mm		
301103	Drill Sleeve	1.8mm		
301007	Aiming Forceps	Open Range 60mm	178mm	352
301107	Aiming Device	Large		
301104	Drill Sleeve	1.8mm		
301105	Drill Sleeve	2.0mm		
301108	Drill Sleeve	2.5mm		

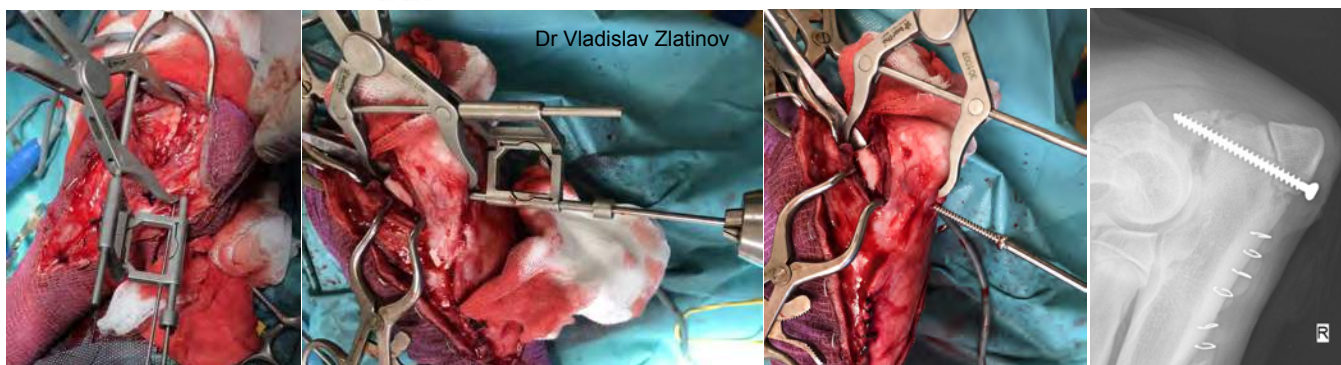

## Micro Bone Holding Forceps, Titanium, Super Light

Veterinary Use Only



Unit mm

Code	Products Name	Specification	L	U.P.\$
301008	Mini Holding Forceps	18mm	120mm	290

## Micrometric Locking Forceps Set



Code	Products Name/Specification	Quantity
301001	Pointed Reduction Forceps Small	1
301002	Pointed Reduction Forceps Large	1
301003	Bone Holding Forceps	2
301004	Condyle Reduction Forceps	1
301005	Mini Holding Forceps	2
301006	Aiming Forceps Small	1
301007	Aiming Forceps Large	1
301010	Sterilization Box For Micrometric Locking Forceps	1

U.P.\$ 2372

# AO Style Reduction Forceps

## Pointed Reduction Forceps

Veterinary Use Only

Unit mm



Code	Products Name	Specification	L	U.P.\$
100000	Pointed Reduction Forceps	Medium	160mm	71
100001	Pointed Reduction Forceps	Small	135mm	71
100002	Pointed Reduction Forceps	Very Small	100mm	77.4
100003	Pointed Reduction Forceps	Large	180mm	64.5

## Pointed Reduction Forceps with Spinlock

Veterinary Use Only

Unit mm



Code	Products Name	Specification	U.P.\$
100004S	Pointed Reduction Forceps with Spinlock	Small 135mm	206.5
100004	Pointed Reduction Forceps with Spinlock	Large 180mm	190.3

## Pointed Reduction Forceps With Double Ratches

Veterinary Use Only

Unit mm



Code	Products Name	Specification	L	U.P.\$
100005	Pointed Reduction Forceps With Double Ratches	Very Large	205mm	93.5



## Bone Holding Forceps with Jaws

Veterinary Use Only

Unit mm



Code	Products Name	L	U.P.\$
100006	Bone Holding Forceps with Jaws	150mm	61.3

# Mini Bone Forceps

## Bone Holding Forceps with Round Jaws

Veterinary Use Only

Unit mm



Code	Products Name	L	U.P.\$
110006	Bone Holding Forceps with Round Jaws	140mm	51.6

## Bone Holding Forceps-Pointed With Jaws

Veterinary Use Only

Unit mm



Code	Products Name	L	U.P.\$
100301	Bone Holding Forceps-Pointed With Jaws	140mm	109.7

## Reduction Forceps With Small Point

Veterinary Use Only

Unit mm



Code	Products Name	L	U.P.\$
100302	Reduction Forceps With Small Point	130mm	109.7

Small Pointed Reduction Forceps With Ball Heads

Veterinary Use Only



Unit mm

Code	Products Name	L	U.P.\$
100303	Small Pointed Reduction Forceps With Ball Heads	135mm	110
100026a	Plate Holding Forceps With Ball Heads	160mm	90



Multi-purpose Holding Forceps

Veterinary Use Only



Unit mm

Code	Products Name	L	U.P.\$
100026c	Multi-purpose Holding Forceps	135mm	139



Mini Serrated Bone Holding Forceps

Veterinary Use Only



Unit mm

Code	Products Name	Specification	U.P.\$
100014	Mini Serrated Bone Holding Forceps	12mm 180mm	94
100015	Mini Serrated Bone Holding Forceps	7mm 140mm	84
100016	Mini Serrated Bone Holding Forceps	5mm 140mm	84
100017	Mini Serrated Bone Holding Forceps	3mm 140mm	84





# Soft Ratchet Reduction Forceps

## Reduction Forceps with Serrated Jaws

Veterinary Use Only



Unit mm

Code	Products Name	L	U.P.\$
100008	Reduction Forceps with Serrated Jaws	150mm	190.3

## Reduction Forceps with Points

Veterinary Use Only



Unit mm

Code	Products Name	L	U.P.\$
100009	Reduction Forceps with Points	150mm	190.3

## Reduction Forceps with small Point

Veterinary Use Only



Unit mm

Code	Products Name	L	U.P.\$
100009b	Reduction Forceps with small Point	150mm	206.5

## Plate Holding Forceps

Veterinary Use Only



Unit mm

Code	Products Name	L	U.P.\$
100026b	Plate Holding Forceps	160mm	206.5



Bone Holding Forceps With Serrated Jaws/Spinlock

Veterinary Use Only



Unit mm

Code	Products Name	L	U.P.\$
100012	Bone Holding Forceps With Serrated Jaws/Spinlock	180mm	71
100013	Bone Holding Forceps With Serrated Jaws/Spinlock	205mm	71



Small Curved Serrated Reduction Forceps

Veterinary Use Only



Unit mm

Code	Products Name	L	U.P.\$
100018	Small Curved Serrated Reduction Forceps	150mm	100

Verbrugge Self Centering Bone Holding Forceps

Veterinary Use Only



Unit mm

Code	Products Name	Specification	L	U.P.\$
100019	Verbrugge Self Centering Bone Holding Forceps	Very Small	150mm	100
100020	Verbrugge Self Centering Bone Holding Forceps	Small	180mm	100
100021	Verbrugge Self Centering Bone Holding Forceps	Large	240mm	100

KERN Bone Holding Forceps

Veterinary Use Only



Unit mm

Code	Products Name	L	U.P.\$
100022	Mini KERN Bone Holding Forceps	140mm	180.6
100023	KERN Bone Holding Forceps	180mm	164.5

### Double Pointed Reduction Forceps with Spinlock

Veterinary Use Only



Code	Products Name	Unit mm	
		L	U.P.\$
100010	Double Pointed Reduction Forceps with Spinlock	180mm	109.7
100010a	Pointed Reduction Forceps With Spinlock	180mm	109.7



### Plate Holding Forceps

Veterinary Use Only



Code	Products Name	L	Unit mm
			U.P.\$
100011	Plate Holding Forceps	150mm	93.5

### Lowman Bone Clamp

Veterinary Use Only



Code	Products Name	Specification	Unit mm	
			L	U.P.\$
100024	Lowman Bone Clamp<15mm	Small	80mm	125.8
100025	Lowman Bone Clamp<30mm	Large	120mm	109.7



### Temporary Reduction-Plate Holding Threaded Pins

Veterinary Use Only

Code	Products Name	Specification	Unit mm
			U.P.\$
PRW125	Temporary Reduction-Plate Holding Threaded Pins	1.25mm 3.5mm	14.2
PRW150	Temporary Reduction-Plate Holding Threaded Pins	1.50mm 5.5mm	15.8



# Implants Cutting Tools

## Safety Rod Cutter

Veterinary Use Only

Unit mm



Code	Products Name	Specification	L	U.P.\$
100027	Safety Rod Cutter	2.5/3.0/4.0mm	300mm	320



## Implants Cutter With Disassemble Handles

Veterinary Use Only

Unit mm



Code	Products Name	Capacity	L	U.P.\$
100028	Implant Cutter Large	6mm	530mm	180
110028	Implant Cutter Medium	4mm	370mm	165



Autoclavable in sterilization box 200002



## Wire/Small Pin Cutter

Veterinary Use Only

Unit mm



Code	Products Name	Capacity	L	U.P.\$
100029	Wire/Small Pin Cutter	1.5mm	180mm	83.9

## Safety Pin Cutter

Veterinary Use Only



Unit mm

Code	Products Name	Capacity	L	U.P.\$
100030	Safety Pin Cutter	2.0/2.5/3.0mm	205mm	106.5

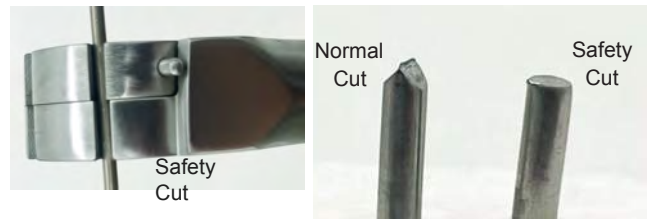

## End Cutting Pliers

Veterinary Use Only

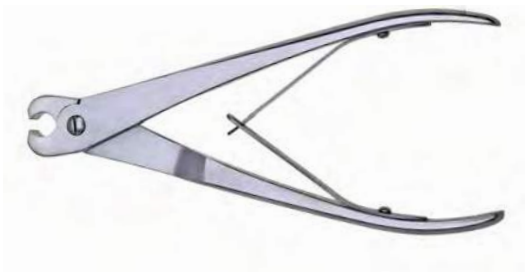

Unit mm

Code	Products Name	Capacity	L	U.P.\$
100031	End Cutting Pliers	2.5mm	235mm	90.3

## Implant Cutting Pliers

Veterinary Use Only

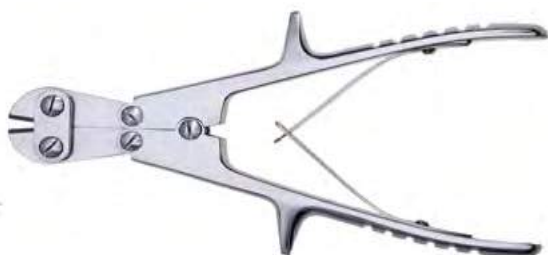

Unit mm

Code	Products Name	Capacity	L	U.P.\$
100032	Implant Cutting Pliers	2.5mm	210mm	83.9

## Pin Pliers Modified Jaw/Flat Nose

Veterinary Use Only



Unit mm

Code	Products Name	L	U.P.\$
100033	Pin Pliers Modified Jaw/Flat Nose	220mm	45.2

Tip Width  
10.5mm

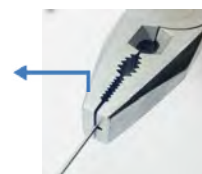

Pin Pliers Modified Jaw/Narrow Nose

Veterinary Use Only

Unit mm



Code	Products Name	L	U.P.\$
100034	Pin Pliers Modified Jaw/Narrow Nose	200mm	41.9

Tip Width  
3.5mm



Small Pin/Wire Pliers

Veterinary Use Only

Unit mm



Code	Products Name	L	U.P.\$
100035	Small Pin/Wire Pliers	150mm	64.5

Tip Width  
2.0mm



Parallel Action Pliers

Veterinary Use Only

Unit mm



Code	Products Name	L	U.P.\$
100036	Parallel Action Pliers	165mm	106.5

Wire/Small Pin Cutter

Veterinary Use Only

Unit mm



Code	Products Name	Specification	L	U.P.\$
100037	Wire/Small Pin Cutter	2.2mm	180mm	138.7



### Wire/Small Pin Cutter

Veterinary Use Only

Unit mm



Code	Products Name	Capacity	L	U.P.\$
110138	Wire/Small Pin Cutter	1.2mm	140mm	109.7

### Plate/Pin Cutting Plier TC Gold

Veterinary Use Only

Unit mm



Code	Products Name	Capacity	L	U.P.\$
100038	Plate/Pin Cutting Plier TC Gold	2.8mm	230mm	432.3

### Implant Cutter, Side And End Cutting, TC Gold

Veterinary Use Only

Unit mm



Code	Products Name	Capacity	L	U.P.\$
110039	Implant Cutter	1.8mm	180mm	367.7

### Plate/Pin Cutting Plier TC Gold

Veterinary Use Only

Unit mm



Code	Products Name	Capacity	L	U.P.\$
100039	Plate/Pin Cutting Plier TC Gold	2.8mm	230mm	416.1
100040	Plate/Pin Cutting Plier TC Gold	2.2mm	170mm	367.7

Front End Wire Cutting Plier TC Gold

Veterinary Use Only



Unit mm

Code	Products Name	Capacity	L	U.P.\$
100041	Front End Wire Cutting Plier TC Gold	2.8mm	230mm	416.1

Front End Wire Cutting Plier TC Gold

Veterinary Use Only



Unit mm

Code	Products Name	Capacity	L	U.P.\$
110041	Front End Wire Cutting Plier TC Gold	1.5mm	160mm	351.6

Small Jacobs Chuck With Straight Handle

Veterinary Use Only



Unit mm

Code	Products Name	Dia	U.P.\$
100042	Small Jacobs Chuck With Straight Handle	0-4mm	132.3

Jacobs Chuck With T Handle (Self-Lock)

Veterinary Use Only



Unit mm

Code	Products Name	Dia	U.P.\$
100043	Jacobs Chuck With T Handle (Self-Lock)	0-6mm	406.5

Jacobs Chuck With T Handle(Self-Lock)

Veterinary Use Only



Unit mm

Code	Products Name	Dia	U.P.\$
100044	Jacobs Chuck With T Handle(Self-Lock)	0-6mm	406.5



# Osteotomes and Mallets

## Osteotomes

Veterinary Use Only



Unit mm

Code	Products Name	Specification	U.P.\$
100117	Osteotomes	15mmX200mm	35.5
100118	Osteotomes	12mmX200mm	35.5
100119	Osteotomes	10mmX200mm	35.5
100120	Osteotomes	8mmX200mm	35.5
100121	Osteotomes	6mmX180mm	35.5
100122	Osteotomes	5mmX180mm	35.5
110122	Osteotomes	4mmX180mm	35.5
110123	Osteotomes	3mmX180mm	35.5

## Chisels

Veterinary Use Only



Unit mm

Code	Products Name	Specification	U.P.\$
100123	Chisels	15mmX200mm	41.9
100124	Chisels	10mmX200mm	41.9
100125	Chisels	6mmX200mm	41.9

## Modular Osteotomes Complete With 7 Blades

Veterinary Use Only



Unit mm

Code	Products Name	Specification	U.P.\$
100103	Modular Osteotome With 7 Blades	Complete	319.4
100104	Modular Osteotome Replacement Blade	4mm	22.6
100105	Modular Osteotome Replacement Blade	6mm	22.6
100106	Modular Osteotome Replacement Blade	8mm	22.6
100107	Modular Osteotome Replacement Blade	10mm	22.6
100108	Modular Osteotome Replacement Blade	12mm	22.6
100109	Modular Osteotome Replacement Blade	15mm	22.6
100110	Modular Osteotome Replacement Blade	20mm	22.6

## Orthopedic Mallet

Veterinary Use Only



Unit g

Code	Products Name	Specification	U.P.\$
100059	Orthopedic Mallet	150g	45.2
100060	Orthopedic Mallet	270g	48.4
100061	Orthopedic Mallet	350g	51.6



## Hand Saw

Veterinary Use Only



Unit mm

Code	Products Name	Saw Blade Thickness	Depth	L	U.P.\$
100130L	Hand Saw	0.25mm	25mm	130mm	103.2

## Trochleaplasty Bone Saw With Handle

Veterinary Use Only



Unit mm

Code	Products Name	Saw Blade Thickness	Depth	L	U.P.\$
100130S	Trochleaplasty Bone Saw With Handle	0.25mm	15mm	70mm	103.2

## Double Rasps

Veterinary Use Only



Unit mm

Code	Products Name	Specification	L	U.P.\$
100131	Double Rasps	6mm	185	29

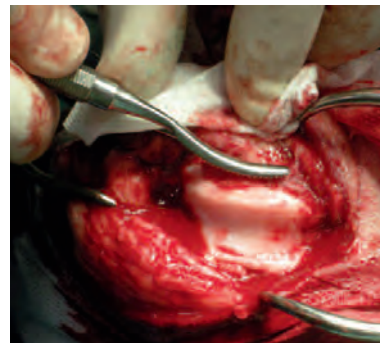

## Trochlea Rasps

Veterinary Use Only



Unit mm

Code	Products Name	Specification	Dia	L	U.P.\$
100132	Trochlea Rasp	Small	3.5mm	180mm	58.1
100133	Trochlea Rasp	Mini	2.2mm	180mm	61.3



## Bone Rasps

Veterinary Use Only



Unit mm

Code	Products Name	Width	U.P.\$
100134	Curved Bone Rasp	5mm	51.6
100135	Straight Bone Rasp	5mm	51.6

## Trochlea Rectangular Sulcoplasty Instruments



## Trochlea Rectangular Sulcoplasty Instruments

Code	Products Name/Specification	Quantity
000001	Trochlea Rectangular Sulcoplasty Instruments	
100130L	Sulcoplasty Bone Saw	1
100132	Trochlea Rasp Small 3.5mm	1
100133	Trochlea Rasp Mini 2.2mm	1
110123	Chisel 3mm	1
110122	Chisel 4mm	1
100122	Chisel 5mm	1
100121	Chisel 6mm	1
100120	Chisel 8mm	1
100119	Chisel 10mm	1
100117	Chisel 15mm	1
100131	Double Rasps	1
100060	Orthopedic Mallet 270g	1
200001	Sterilization Container	1

U.P.\$ 638.8

# Bone Curette

## Walkman Spoon

Veterinary Use Only



Unit mm

Code	Products Name	L	U.P.\$
100055	Walkman Spoon	2mm	58.1
100056	Walkman Spoon	3mm	58.1
100057	Walkman Spoon	4mm	58.1
100058	Walkman Spoon	5mm	58.1

## Bone Curette

Veterinary Use Only



Unit mm,cm

Code	Products Name	Head Width	L	U.P.\$
100195	Bone Curette	3.0/3.5mm	13.5cm	41.9
100196	Bone Curette	2.5/3.0mm	13.5cm	41.9
100197	Bone Curette	2.0/2.5mm	13.5cm	41.9

# Periosteal Elevator

## Mini Double End Periosteal Elevator

Veterinary Use Only

Unit mm



Code	Products Name	L	U.P.\$
100096	Mini Double End Periosteal Elevator	3mm	29
100097	Mini Double End Periosteal Elevator	5mm	29



## Periosteal Elevator(Narrow Flat End)

Veterinary Use Only

Unit mm



Code	Products Name	Flat Edge	Blade	U.P.\$
110098	Periosteal Elevator(Narrow Flat End)	4mm	180mm	45.2
100099	Periosteal Elevator(Narrow Flat End)	6mm	180mm	45.2

## Periosteal Elevator(Curved End)

Veterinary Use Only

Unit mm



Code	Products Name	Curved Edge	Blade	U.P.\$
100098	Periosteal Elevator(Curved End)	6mm	180mm	45.2
100100	Periosteal Elevator(Curved End)	8mm	180mm	45.2

## Periosteal Elevator(Broad Flat End)

Veterinary Use Only

Unit mm



Code	Products Name	Curved Edge	Blade	U.P.\$
100101	Periosteal Elevator(Broad Flat End)	10mm	180mm	41.9
100102	Periosteal Elevator(Broad Flat End)	14mm	180mm	41.9

### Mini Hohman Retractor Narrow Series

Veterinary Use Only



Unit mm

Code	Products Name	Short Tip	L	U.P.\$
100144	Mini Hohman Retractor	6mm	165mm	29
100145	Mini Hohman Retractor	8mm	165mm	29
100146	Mini Hohman Retractor	12mm	165mm	29

### Mini Hohman Retractor Broad

Veterinary Use Only



Unit mm

Code	Products Name	Short Tip	L	U.P.\$
110146	Mini Hohman Retractor Broad	15mm	160mm	51.6

### Micro Hohman Retractor 4mm

Veterinary Use Only



Unit mm

Code	Products Name	L	U.P.\$
100147	Micro Hohman Retractor	160mm	38.7



### Swan-Neck Hohman Reactor

Veterinary Use Only



Unit mm

Code	Products Name	Blade	U.P.\$
100138	Swan-Neck Hohman Reactor	20mm	41.9

## Hip Retractors Series

Veterinary Use Only



Unit mm

Code	Products Name	Specification	U.P.\$
100139	Hip Retractors Series	Large 255mmX25mmX36mm	67.7
100140	Hip Retractors Series	Medium 175mmX13mmX18mm	67.7
100141	Hip Retractors Series	Small 125mmX8mmX12mm	67.7



## Hohman Retractor Broad

Veterinary Use Only

Unit mm

Code	Products Name	Short Narrow Tip	L	U.P.\$
100142	Hohman Retractor Broad	48mm	260mm	35.5
100143	Hohman Retractor Broad	24mm	180mm	51.6



## Hohman Retractor Broad With Double Tips

Veterinary Use Only

Unit mm

Code	Products Name	Blade Width/Specification	U.P.\$
100141b	Hohman Retractor Broad With Double Tips	20mm/155mmX10mmX20mm	67.7



# Hatt Spoon

## Hatt Spoon—Round Ligment Cutter

Veterinary Use Only

Unit mm



Code	Products Name	L	Specification	U.P.\$
300005	Hatt Spoon	280mm	20mmX30mm scoop	93.5
300006	Hatt Spoon	260mm	12mmX18mm scoop	93.5
300007	Hatt Spoon	230mm	8mmX12mm scoop	93.5

## Femoral Head/Neck Excisional Arthroplasty Set



## Femoral Head/Neck Excisional Arthroplasty Set

Code	Products Name/Specification	Quantity
THR0001	Femoral Head/Neck Excisional Arthroplasty Set	
100151/100152	Gelpi Self Retaining Retractor Curved 160mm	2
110156/110157	Double Head Skin Hook	2
100141	Small Hip Hohman 125mmX8mmX12mm	1
100140	Medium Hip Hohman 175mmX13mmX18mm	1
100139	Large Hip Hohman 255mmX25mmX36mm	1
300005	Hatt Spoon 280mm (20mmX30mm scoop)	1
300006	Hatt Spoon 260mm (12mmX18mm scoop)	1
300007	Hatt Spoon 230mm (8mmX12mm scoop)	1
100134/100135	Bone Rasp Curved/Straight	1
200003	Sterilization Container	1

U.P.\$ 625.5



# Bone Rongeur

## Friedman Rongeur Curved

Veterinary Use Only



Unit mm

Code	Products Name	Bite	L	U.P.\$
100078	Mini-Friedman Rongeur Curved	2mm	150mm	77.4
100079	Micro-Friedman Rongeur Curved	3mm	150mm	77.4
110079	Micro-Friedman Rongeur Angled	3mm	150mm	77.4
100080	Large-Friedman Rongeur Curved	5mm	180mm	72.6

## Lempert Roungeurs Straight

Veterinary Use Only



Unit mm

Code	Products Name	Bite	L	U.P.\$
110080	Lempert Roungeurs Straight	3mm	190mm	125.8

## Jansen Double Joints Bone Rongeur

Veterinary Use Only



Unit mm

Code	Products Name	Bite	L	U.P.\$
100081	Jansen Double Joints Rongeur Curved	3mm	150mm	138.7
100082	Jansen Double Joints Rongeur Angled	4mm	150mm	106.5

## Ruskin (Liston) Rongeur Curved

Veterinary Use Only



Unit mm

Code	Products Name	Bite	L	U.P.\$
100083	Ruskin (Liston) Rongeur Curved	2mm	160mm	122.6
100084	Ruskin (Liston) Rongeur Curved	3mm	160mm	122.6
100085	Ruskin (Liston) Rongeur Curved	5mm	180mm	122.6

## Double Joints Bone Rongeur Curved

Veterinary Use Only

Unit mm



Code	Products Name	Bite	L	U.P.\$
100086	Double Joints Bone Rongeur (Curved)	8mm	230mm	154.8

## Leksell Rongeur (Angled)

Veterinary Use Only

Unit mm



Code	Products Name	Bite	L	U.P.\$
100087	Leksell Rongeur (Angled)	5mm	230mm	132.3
100088	Leksell Rongeur (Angled)	8mm	230mm	132.3

## Bone Cutters

## Cleveland Angled Bone Cutter

Veterinary Use Only

Unit mm



Code	Products Name	Blade	L	U.P.\$
100089	Cleveland Angled Bone Cutter	15mm	150mm	90.3

## Liston Bone Cutters

Veterinary Use Only

Unit mm



Code	Products Name	Blade	L	U.P.\$
100090	Liston Bone Cutters (Straight)	25mm	180mm	90.3
110090	Liston Bone Cutters (Curved)	25mm	180mm	90.3

## Littauer Bone Cutters

Veterinary Use Only

Unit mm



Code	Products Name	Blade	L	U.P.\$
100091	Littauer Bone Cutters	15mm	150mm	100

## McIndoe Bone Cutter

Veterinary Use Only

Unit mm



Code	Products Name	Blade	L	U.P.\$
100092	McIndoe Bone Cutter	12mm	150mm	122.6

## Cottle Kazanjian Bone Cutters

Veterinary Use Only

Unit mm



Code	Products Name	Blade	L	U.P.\$
100093	Cottle Kazanjian Bone Cutters (Straight)	25mm	190mm	122.6

## Horsley Bone Cutter

Veterinary Use Only

Unit mm



Code	Products Name	Blade	L	U.P.\$
100094	Horsley Bone Cutter (Straight)	35mm	240mm	138.7
100095	Horsley Bone Cutter (Curved)	35mm	240mm	138.7

# Gelpi Self Retaining Retractor

## Gelpi Self Retaining Retractor

Veterinary Use Only



Unit mm

Code	Products Name	L	U.P.\$
100148	Gelpi Self Retaining Retractor	100mm	74.2
100149	Gelpi Self Retaining Retractor	140mm	77.4
100150	Gelpi Self Retaining Retractor	160mm	80.6

## Gelpi Precision Model

Veterinary Use Only



Unit mm

Code	Products Name	L	U.P.\$
100316	Gelpi Precision Model	135mm	174

## Gelpi With Odd Legs

Veterinary Use Only



Unit mm

Code	Products Name	Open Depth	L	U.P.\$
600270	Gelpi With Odd Legs	20X30	140	100
600271	Gelpi With Odd Legs	30X20	140	100
600272	Gelpi With Odd Legs	25X40	180	109.7
600273	Gelpi With Odd Legs	40X25	180	109.7

## Gelpi With Safe Insertion Legs

Veterinary Use Only



Unit mm

Code	Products Name	Leg L	L	U.P.\$
600280	Gelpi Safe Insertion Legs	30	100	77.4
600281	Gelpi Safe Insertion Legs	15	140	77.4
600282	Gelpi Safe Insertion Legs	40	140	77.4
600283	Gelpi Safe Insertion Legs	20	180	83.9
600284	Gelpi Safe Insertion Legs	50	180	83.9
600285	Gelpi Safe Insertion Legs	60	200	93.5

## Curved Gelpi Self Retaining Retractor

Veterinary Use Only

Unit mm



Code	Products Name	Specification	L	U.P.\$
100151	Curved Gelpi Self Retaining Retractor	Curved	160mm	83.9
100152	Curved Gelpi Self Retaining Retractor	Curved	140mm	93.5

## Weislander Self Retaining Retractor

Veterinary Use Only

Unit mm



Code	Products Name	L	U.P.\$
100153	Weislander Self Retaining Retractor	140mm	93.5
100154	Weislander Self Retaining Retractor	160mm	96.8
100155	Weislander Self Retaining Retractor	180mm	103.2

## West's Self Retaining Retractor

Veterinary Use Only

Unit mm



Code	Products Name	L	U.P.\$
100156	West's Self Retaining Retractor	140mm	125.8
100157	West's Self Retaining Retractor	160mm	132.3
100158	West's Self Retaining Retractor	180mm	138.7

## Mini Soft Tissues Self Retaining Retractor

Veterinary Use Only

Unit mm



Code	Products Name	Range	L	U.P.\$
110200	Mini Soft Tissues Self Retaining Retractor	0-25mm	100mm	111.3

## Senn Retactor

Veterinary Use Only



Unit mm

Code	Products Name	Specification	U.P.\$
110156	Senn Retactor	Sharp	41.9
110157	Senn Retactor	Blunt	41.9

## Soft Tiusse Retracting Hooks With Grip Handle

Veterinary Use Only



Unit mm

Code	Products Name	U.P.\$
110158	Soft Tiusse Retracting Hooks With Grip Handle	41.9
110159	Soft Tiusse Retracting Hooks With Grip Handle	41.9

## Joseph Retracting Hooks

Veterinary Use Only



Unit mm

Code	Products Name	L	U.P.\$
100199	Joseph Retracting Hooks	160mmX3mm	41.9
100203	Joseph Retracting Hooks	160mmX6mm	41.9

## Double Deep Retractor

Veterinary Use Only



Unit mm

Code	Products Name	Specification	U.P.\$
100204	Double Deep Retractor	200X40X20mm	45

# AO Quick Coupling Handle

## T Shape Quick Couple Handle

Veterinary Use Only



Unit mm

Code	Products Name	Used For	L	U.P.\$
100159	T Tap Handle	2.4,2.7,3.5,4.0,4.5 Taps	75mm	83.9

## Straight Quick Couple Handle

Veterinary Use Only



Unit mm

Code	Products Name	Specification	L	U.P.\$
110160	QC Handle	Large	160mm	100
100160	QC Handle	Small	110mm	100
100160	AO QC Handle	Medium	200mm	100

## AO QCK / Jacob Converter

Veterinary Use Only



Code	Products Name	U.P.\$
111160	AO QCK/Jacob Converter	84



## Ratcheting Screwdriver Handle

Veterinary Use Only



Code	Products Name	U.P.\$
120160	Ratcheting Screwdriver Handle	272

# Screwdriver+Sleeves

## Screwdriver For 1.5/2.0/2.4mm Screw

Veterinary Use Only



Unit mm

Code	Products Name/Screw Specification	Specification	U.P.\$
100217	Screw holding Sleeve, 1.5/2.0/2.4mm		22.6
100218	Hex Screwdriver with Fibre Handle, 1.5/2.0/2.4mm	1.5mm	22.6
100219	Hex Screwdriver+Sleeve with Fibre Handle, 1.5/2.0/2.4mm	1.5mm	41.9

Screwdriver+Sleeve For 1.5/2.0/2.4mm Screw.

## Screwdriver For 2.7/3.0/3.5/4.0mm Screw

Veterinary Use Only



Unit mm

Code	Products Name/Screw Specification	Specification	U.P.\$
100220	Screw holding Sleeve, 2.7/3.0/3.5/4.0mm		22.6
100221	Hex Screwdriver with Fibre Handle, 2.7/3.0/3.5/4.0mm	2.5mm	22.6
100222	Hex Screwdriver+Sleeve with Fibre Handle, 2.7/3.0/3.5/4.0mm	2.5mm	41.9

Screwdriver+Sleeve For 2.7/3.0/3.5/4.0mm Screw.

## Screwdriver For 4.5/6.0mm Screw

Veterinary Use Only



Unit mm

Code	Products Name/Screw Specification	Specification	U.P.\$
100223	Screw holding Sleeve, 4.5/6.0mm		22.6
100224	Hex Screwdriver with Fibre Handle, 4.5/6.0mm	3.5mm	22.6
100225	Hex Screwdriver+Sleeve with Fibre Handle, 4.5/6.0mm	3.5mm	41.9

## Torx Type Screwdriver

Veterinary Use Only



Unit mm

Code	Products Name	For Screw	U.P.\$
100257	T6 Torx Type Screwdriver	TCS15/20 B24 CSTT20 LS20	48.4
100320	T8 Torx Type Screwdriver	CSTT24/27 LS24/27	48.4
100258	T10 Torx Type Screwdriver	TCS24/27 B32/40	48.4
100321	T15 Torx Type Screwdriver	CSTT35 LS35	48.4
100321	T15 Torx Type Screwdriver(Aluminium)	CSTT35 LS35	48.4



# Quick Coupling Screwdriver

Quick Coupling Screwdriver

Veterinary Use Only

Unit mm



Code	Products Name	For Screw	U.P.\$
100226	Hex Screwdriver AO QC1.5mm	CSST15/20/24 CAN22/30	29
100227	Hex Screwdriver AO QC2.0mm		29
100228	Hex Screwdriver AO QC2.5mm	CSST27/35 CAN30/40	29
100229	Hex Screwdriver AO QC3.5mm	CSST45/55	29
100200	AO QC Square Head 1.2mm		29
100201	AO QC Square Head 1.5mm		29
100202	AO QC Square Head 2.0mm		29

# Torx Drive Screwdriver shaft

Torx Drive Screwdriver shaft

Veterinary Use Only

Unit mm



Code	Products Name	For Screw	U.P.\$
100230	T15 Torx Drive Screwdriver shaft	AO3.5mm Locking	45.2
100231	T8 Torx Drive Screwdriver shaft	AO2.4/2.7mm Locking	45.2
100232	T6 Torx Drive Screwdriver shaft	AO2.0mm,B2.4mm Locking	45.2
1002310	T10 Torx Drive Screwdriver shaft	B4.0mm Locking	45.2
110232	T4 Torx Drive Screwdriver shaft	AO1.2/1.5mm Locking	45.2
110230	T25 Torx Drive Screwdriver shaft	AO5.0mm Locking	45.2

# Drill Bits

## Drill Bits

Veterinary Use Only

Unit mm



Code	Products Name	Dia	L	U.P.\$
A32A08	Drill Bits	0.8mm	60mm	3.2
A32A10	Drill Bits	1.0mm	60mm	3.2
A32A11	Drill Bits	1.1mm	60mm	3.2
A32A12	Drill Bits	1.2mm	60mm	3.2
A32A15	Drill Bits	1.5mm	85mm	3.2
A32A18	Drill Bits	1.8mm	100mm	3.2
A32A20	Drill Bits	2.0mm	100mm	3.2
A32A25	Drill Bits	2.5mm	115mm	3.2
A32A27	Drill Bits	2.7mm	165mm	4.8
A32A30	Drill Bits	3.0mm	150mm	4.8
A32A32	Drill Bits	3.2mm	150mm	4.8
A32A35	Drill Bits	3.5mm	150mm	4.8
A32A40	Drill Bits	4.0mm	150mm	4.8
A32A45	Drill Bits	4.5mm	150mm	4.8

## AO Style Quick Coupling Drill Bits

Veterinary Use Only

Unit mm



Code	Products Name	Dia	L	U.P.\$
A32QC08	AO Style Quick Coupling Drill Bits	0.8mm	60mm	25.8
A32QC11	AO Style Quick Coupling Drill Bits	1.1mm	60mm	25.8
A32QC15	AO Style Quick Coupling Drill Bits	1.5mm	85mm	24.2
A32QC18	AO Style Quick Coupling Drill Bits	1.8mm	100mm	24.2
A32QC20	AO Style Quick Coupling Drill Bits	2.0mm	125mm	24.2
A32QC24	AO Style Quick Coupling Drill Bits	2.4mm	125mm	19.4
A32QC25	AO Style Quick Coupling Drill Bits	2.5mm	150mm	19.4
A32QC27	AO Style Quick Coupling Drill Bits	2.7mm	150mm	19.4
A32QC32	AO Style Quick Coupling Drill Bits	3.2mm	150mm	16.1
A32QC35	AO Style Quick Coupling Drill Bits	3.5mm	150mm	16.1
A32QC45	AO Style Quick Coupling Drill Bits	4.5mm	160mm	16.1
A32QC20L	AO Style Quick Coupling Drill Bits	2.0mm	165mm	24.2
A32QC25L	AO Style Quick Coupling Drill Bits	2.5mm	205mm	29
A32QC27L	AO Style Quick Coupling Drill Bits	2.7mm	205mm	29
A32QC32L	AO Style Quick Coupling Drill Bits	3.2mm	230mm	29
A32QC32LL	AO Style Quick Coupling Drill Bits	3.2mm	230mm	29
A32QC37L	AO Style Quick Coupling Drill Bits	3.7mm	350mm	35.5

## Cannulated Drill Bits

Veterinary Use Only

Unit mm



Code	Products Name	External Dia	Guide Pin	L	U.P.\$
A32CAN20	Cannulated Drills	2.0mm	1.2mm	150mm	109.7
A32CAN27	Cannulated Drills	2.7mm	1.2mm	150mm	93.5
A32CAN32	Cannulated Drills	3.2mm	1.5mm	150mm	80.6
A32CAN50	Cannulated Drills	5.0mm	2.5mm	250mm	125.8
A32CAN27QC	AO Cannulated Drills	2.7mm	1.5mm	160mm	141.9
A32CAN30	Cannulated Drills	3.0mm	1.5mm	130mm	96.8
A32CAN47	Cannulated Drills	4.7mm	3.2mm	300mm	109.7

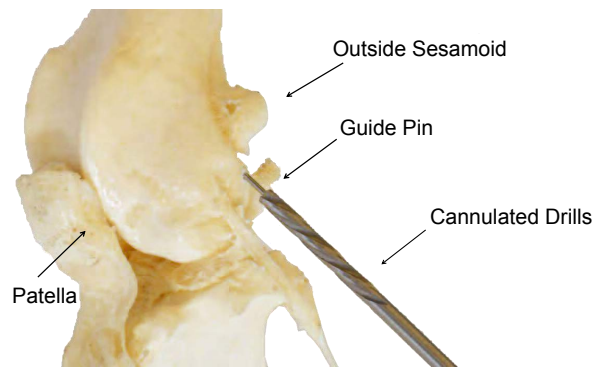

## Drill Stoppers Set

Veterinary Use Only

Unit mm



Code	Products Name	U.P.\$
100208	Drill Stoppers Set	100



For Drill Bit Diameter  
 1.5/1.8/2.0/2.4/2.5/2.7  
 2.8/3.0/3.2/3.5/4.0/4.3mm  
 With Hex1.5/2.5 Key

# Taps

## T Handle Taps

Veterinary Use Only

Unit mm



Code	Products Name	Specification	Screw Pitch	U.P.\$
100161	T Handle Taps Cortical	1.5mm		41.9
100162	T Handle Taps Cortical	2.0mm	0.6mm	41.9
100163	T Handle Taps Cancellous	2.2mm	1.0mm	41.9
100164	T Handle Taps Cortical	2.4mm		41.9
100165	T Handle Taps Cortical	2.7mm		41.9
100166	T Handle Taps Cortical	3.5mm		41.9
100167	T Handle Taps Cancellous	4.0mm		41.9
100168	T Handle Taps Cortical	4.5mm		41.9
100169	T Handle Taps Cancellous	6.5mm		41.9

## AO Quick Coupling Taps

Veterinary Use Only

Unit mm



Code	Products Name	Specification	U.P.\$
100170	AO Quick Coupling Taps Cortical	1.5mm	41.9
100171	AO Quick Coupling Taps Cortical	2.0mm	41.9
100172	AO Quick Coupling Taps Cortical	2.4mm	41.9
100173	AO Quick Coupling Taps Cortical	2.7mm	41.9
100174	AO Quick Coupling Taps Cortical	3.5mm	41.9
100175	AO Quick Coupling Taps Cancellous	4.0mm	41.9
100176	AO Quick Coupling Taps Cortical	4.5mm	41.9
100177	AO Quick Coupling Taps Cancellous	6.5mm	41.9

# Countersink

## Countersink AO Quick Fit Coupling

Veterinary Use Only

Unit mm



Code	Products Name	Dia	U.P.\$
100239b	Countersink AO Quick Fit Coupling	Φ3mm	61.3
100240	Countersink AO Quick Fit Coupling	Φ4mm	58.1
100241	Countersink AO Quick Fit Coupling	Φ5mm	51.6
100242	Countersink AO Quick Fit Coupling	Φ6mm	45.2

## Countersink 'T' Handle

Veterinary Use Only

Unit mm



Code	Products Name	Specification	U.P.\$
100243	Countersink'T'Handle	1.5/2.0/2.4	51.6
100244	Countersink'T'Handle	2.7/3.0/3.5/4.0	48.4
100245	Countersink'T'Handle	4.5/6.0	41.9

# Drill Guides

## Double Drill Guide

Veterinary Use Only



Unit mm

Code	Products Name	Specification	U.P.\$
100187	Double Drill Guide	0.8/1.1	67.7
100178	Double Drill Guide	1.1/1.5	51.6
100179	Double Drill Guide	1.5/2.0	48.4
100180	Double Drill Guide	1.8/2.4	45.2
100181	Double Drill Guide	2.0/2.7	41.9
100182	Double Drill Guide	2.5/3.5	38.7
100183	Double Drill Guide	3.2/4.5	35.5

## Universal Drill Guide

Veterinary Use Only



Unit mm

Code	Products Name	Specification	U.P.\$
100188	Universal Drill Guide	1.5/2.0	141.9
100189	Universal Drill Guide	1.8/2.4	125.8
100190	Universal Drill Guide	2.0/2.7	125.8
100191	Universal Drill Guide	2.5/3.5	93.5

## Parallel Drill Guide

Veterinary Use Only



Unit mm

Code	Products Name	For Drill Bits	U.P.\$
100192	Parallel Drill Guide	2.0mm	100
100194	Parallel Drill Guide	1.5mm	100

## Aiming Drill Guide

Veterinary Use Only



Unit mm

Code	Products Name	Specification	Inner Dia	L	U.P.\$
100206	Aiming Drill Guide	Small	3.5mm	135mm	67.7

Load And Neutral Drill Guides For LC-DCP And DCP

Veterinary Use Only

Unit mm



Code	Products Name	Used For	U.P.\$
100211	Load Neutral Drill Guides	2.0mm Compression Plates	100
100212	Load Neutral Drill Guides	2.4mm Compression Plates	96.8
100213	Load Neutral Drill Guides	2.7mm Compression Plates	90.3
100215	Load Neutral Drill Guides	3.5mm Compression Plates	83.9
100216	Load Neutral Drill Guides	4.5mm Compression Plates	83.9

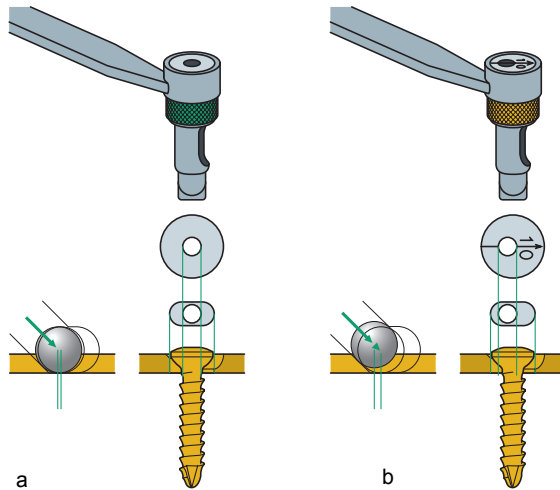

The application of the drill guide depends on the function which the screw should have:

- a Neutral position (green end of guide)
- b Compression mode (gold end of the guid)

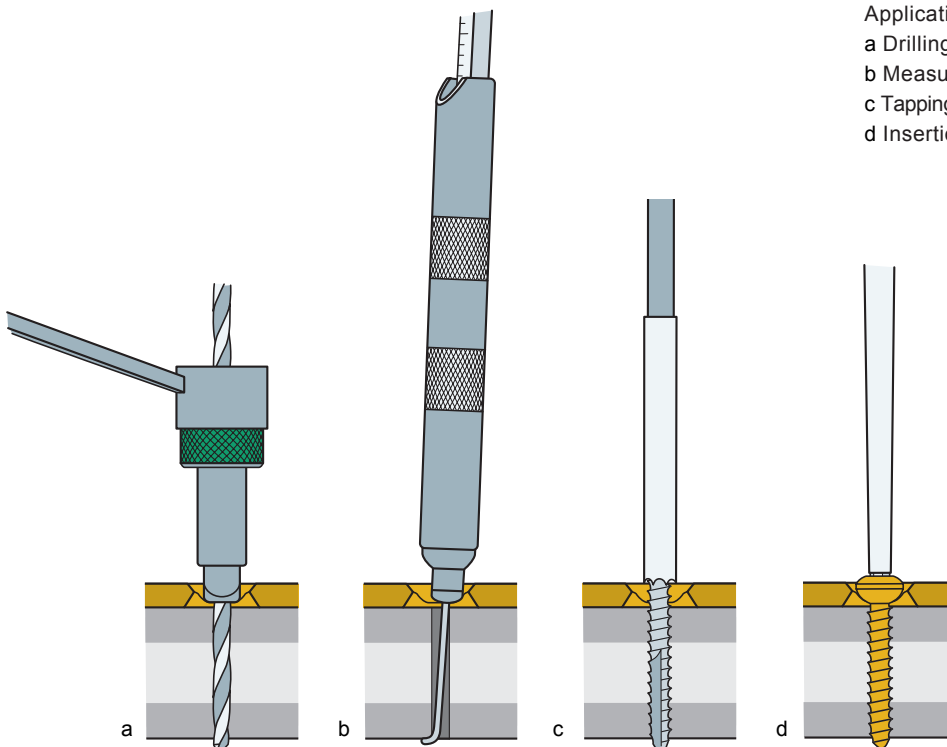

- Application of a plate screw:
- a Drilling of the hole in neutral position
  - b Measuring the hole length
  - c Tapping
  - d Insertion of the screw

# Depth Gauge

## Depth Gauge

Veterinary Use Only

Unit mm



Code	Products Name	For Screws	Range	U.P.\$
100236	Depth Gauge	1.5mm/2.0mm	0-30mm	74.2
100237	Depth Gauge	2.4mm/2.7mm	0-50mm	64.5
100238	Depth Gauge	3.5mm/4.0mm	0-60mm	61.3
100239	Depth Gauge	4.5mm/6.0mm	0-90mm	58.1

## Three Scales Depth Gauge

Veterinary Use Only

Unit mm



Code	Products Name	For Screws	Range	U.P.\$
100336	Three Scales Depth Gauge	1.5mm/2.0mm	0-30mm	93.5
100337	Three Scales Depth Gauge	2.4mm/2.7mm	0-50mm	89.5

Precise screw measurement is important in Small Animal surgery. To accommodate your preference, the depth gauges can be utilized in a single or two-handed mode. Also for your convenience, it has three scales which you can read from for your measurement.

## Screw Holding Forceps

Veterinary Use Only

Unit mm



Code	Products Name	For Screws	U.P.\$
100233	Screw Holding Forceps	2.7/3.0/3.5/4.0	19.4
100234	Screw Holding Forceps	1.5/2.0/2.4	19.4
100235	Screw Holding Forceps	4.5/6.0	19.4

## Bone Plate Template

Veterinary Use Only



Unit mm

Code	Products Name	Wide	Use For	U.P.\$
100310	Bone Plate Template	4.8	1.5/2.0LC-DCP and LCP	12.6
100311	Bone Plate Template	6	2.4LC-DCP and LCP	12.6
100312	Bone Plate Template	8	2.7LC-DCP and LCP	12.6
100313	Bone Plate Template	10	Narrow 3.5LC-DCP and LCP	12.6
100314	Bone Plate Template	12	Broad 3.5LC-DCP and LCP	12.6

# Bending Irons

## Bending Irons Mini

Veterinary Use Only



Unit mm

Code	Products Name	Specification	L	U.P.\$
100065	Bending Iron Mini	AO 1.5/2.0/2.4	140mm	90.3

## Bending Irons Small

Veterinary Use Only

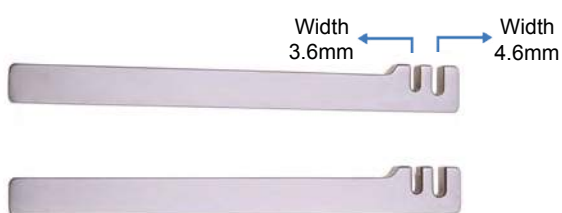

Unit mm

Code	Products Name	Specification	L	U.P.\$
100066	Bending Iron Small	AO2.7/3.5	175mm	51.6

## Bending Irons Large

Veterinary Use Only



Unit mm

Code	Products Name	Specification	L	U.P.\$
100067	Bending Iron Large	AO3.5/4.5	270mm	58.1



# Reconstruction Bending Irons

## Reconstruction Type Bending Irons (Pair)

Veterinary Use Only

Unit mm

Code	Products Name	Specification	L	U.P.\$
100068	Recon Bending Iron	BW 1.5/2.0	140mm	106.5
100069	Recon Bending Iron	BW 2.4/2.7	140mm	106.5
100070	Recon Bending Iron	BW 3.5	200mm	93.5

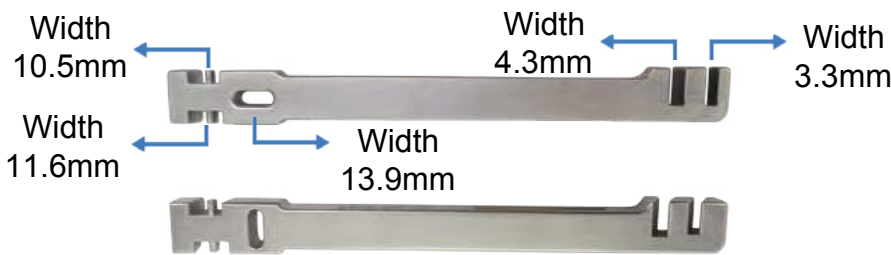
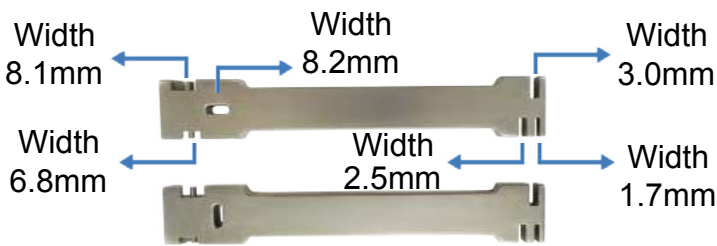
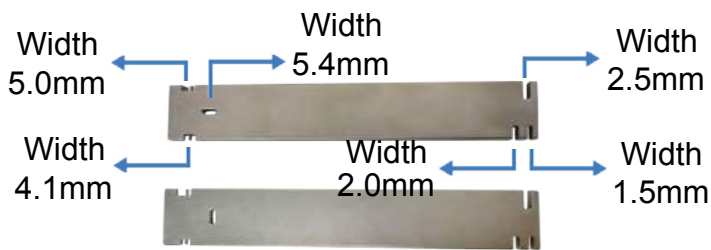

## 3.5mm Reconstruction Plate Plier

Veterinary Use Only

Unit mm

Code	Products Name	Specification	L	U.P.\$
100071	Reconstruction Plate Plier	3.5mm	280mm	174.2



Plate Bending Plier Roller Type

Veterinary Use Only

Unit mm



Code	Products Name	L	U.P.\$
100072	Plate Bending Plier Roller Type	380mm	254.8



Reconstruction Plate Bender

Veterinary Use Only

Unit mm



Code	Products Name	U.P.\$
100073	Reconstruction Plate Bender	577.4



Bone Plate Bending Press Heavy Duty

Veterinary Use Only

Unit mm



Code	Products Name	U.P.\$
100076	Bone Plate Press	1238.7



## Screw Extractor

Veterinary Use Only

Unit mm



Code	Products Name	Specification	U.P.\$
100256	Screw Extractor	SW2.5/T10	45.2
100255	Screw Extractor	SW1.5/T8	45.2
100254	Screw Extractor	SW1.2/T6	45.2
100253	Screw Extractor(Lower Limbs)	SW3.5mm	41.9

## High Speed Drill Bit For Implant Metal

Veterinary Use Only

Unit mm



Code	Products Name	U.P.\$
100327	High Speed Drill Bit For Implant Metal 3	48.4
100328	High Speed Drill Bit For Implant Metal 4	48.4
100329	High Speed Drill Bit For Implant Metal 5	48.4

## Extraction Trepine

Veterinary Use Only

Unit mm



Code	Products Name	For Screws	U.P.\$
100246	Extraction Trepine	1.5mm	51.6
100247	Extraction Trepine	2.0mm	51.6
100248	Extraction Trepine	2.4mm	51.6
100249	Extraction Trepine	2.7mm	51.6
100250	Extraction Trepine	3.5mm	51.6
100251	Extraction Trepine	4.0mm	41.9

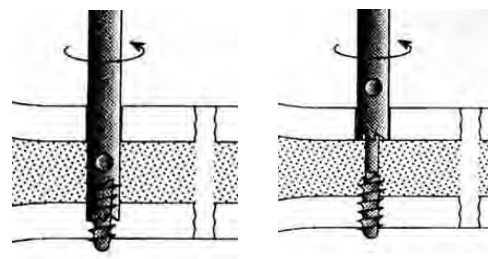

# Small Animal Implants Removal Set



## Small Animal Implants Removal Set

Code	Products Name/Specification	Quantity
100160	AO Quick Coupling Handle 110mm	1
100035	Small Pin Plier 150mm	1
100246	Extraction Trephine, For 1.5 Screws	1
100247	Extraction Trephine, For 2.0 Screws	1
100248	Extraction Trephine, For 2.4 Screws	1
100249	Extraction Trephine, For 2.7 Screws	1
100250	Extraction Trephine, For 3.5 Screws	1
100251	Extraction Trephine, For 4.0 Screws	1
100200	AO QC Square Head 1.2mm	1
100201	AO QC Square Head 1.5mm	1
100232	T6 Star Drive Screwdriver shaft	1
100231	T8 Star Drive Screwdriver shaft	1
100230	T15 Star Drive Screwdriver shaft	1
1002310	T10 Star Drive Screwdriver shaft	1
100226	Hex Screwdriver AO QC1.5mm	1
100228	Hex Screwdriver AO QC2.5mm	1
100254	AO Screw Extractor SW1.2/T6	1
100255	AO Screw Extractor SW1.5/T8	1
100256	AO Screw Extractor SW2.5/T10	1
100253	AO Screw Extractor SW3.5mm(Lower Limbs)	1
100327	High Speed Drill Bit 3	1
100328	High Speed Drill Bit 4	1
100329	High Speed Drill Bit 5	1
100330	Small Animal Implants Removal Box	1

U.P.\$

1074

# Bone Models

## Tibia Model

Veterinary Use Only



Unit mm

Code	Products Name	L	U.P.\$
M0001	Tibia Model	250mm	12.6

## Ulna Model

Veterinary Use Only



Unit mm

Code	Products Name	L	U.P.\$
M0002	Ulna Model	170mm	11.3

## Radius Model

Veterinary Use Only



Unit mm

Code	Products Name	L	U.P.\$
M0003	Radius Model	170mm	11.3

## Pelvis Model

Veterinary Use Only



Unit mm

Code	Products Name	L	U.P.\$
M0004	Pelvis Model	175mm	11.3

Femur Model

Veterinary Use Only



Unit mm

Code	Products Name	L	U.P.\$
M0005	Femur Model	210mm	11.6

Humerus Model

Veterinary Use Only



Unit mm

Code	Products Name	L	U.P.\$
M0006	Humerus Model	170mm	11.6

Femur Hollow Model

Veterinary Use Only



Unit mm

Code	Products Name	L	U.P.\$
M0007	Femur Hollow Model	210mm	11.6

Tubular model

Veterinary Use Only



Unit mm

Code	Products Name	L	U.P.\$
M0012	Tubular model	180mm	12.6

## Posterior Limb+Pelvis+Hip Joint

Veterinary Use Only



Unit mm

Code	Products Name	U.P.\$
N0001	Posterior Limb+Pelvis+Hip Joint	154.8

## Femur Model

Veterinary Use Only



Unit mm

Code	Products Name	L	U.P.\$
N0002	Femur Model	78mm	17.7

## Pelvis Model

Veterinary Use Only



Unit mm

Code	Products Name	U.P.\$
N0003	Pelvis Model	16.1

## Radioulna Model

Veterinary Use Only



Unit mm

Code	Products Name	L	U.P.\$
N0004	Radioulna Model	80mm	21

## Humerus Model

Veterinary Use Only



Unit mm

Code	Products Name	L	U.P.\$
N0005	Humerus Model	72mm	17.7

## Tibia Model

Veterinary Use Only



Unit mm

Code	Products Name	L	U.P.\$
N0006	Tibia Model	75mm	17.7

## Anterior limb Model

Veterinary Use Only



Unit mm

Code	Products Name	U.P.\$
N0007	Anterior limb Model	48.4

## Knee-joint Model

Veterinary Use Only



Unit mm

Code	Products Name	U.P.\$
N0008	Knee-joint Model	106.5



## Skull Model

Veterinary Use Only



Unit mm

Code	Products Name	U.P.\$
M0014	Skull Model	96.8

## Spine Model

Veterinary Use Only



Unit mm

Code	Products Name	U.P.\$
L0002	Spine Model	641.9

## Anterior Limb Model

Veterinary Use Only



Unit mm

Code	Products Name	U.P.\$
L0004	Anterior Limb Model	303.2

## Posterior Limb Model

Veterinary Use Only



Unit mm

Code	Products Name	U.P.\$
L0003	Posterior Limb Model	319.4

## Canie Bone Model

Veterinary Use Only



Unit mm

Code	Products Name	Texture	U.P.\$
M0008	Canie Bone Model	PVC	93.5

## Horse Hoof Model

Veterinary Use Only



Unit mm

Code	Products Name	U.P.\$
L0005	Horse Hoof Model	395.2

# Pre Operative Planing Tools

## Surgical Measuring Ruler With Gauge Holes

Veterinary Use Only

Unit mm



Code	Products Name	L	U.P.\$
M0009	Surgical Measuring Ruler With Gauge Holes	150mm	15.8

## Orthopedic Caliper

Veterinary Use Only

Unit mm



Code	Products Name	Range	U.P.\$
M0035	Orthopedic Caliper	0-140mm	158.1

## X Ray Reference Ball

Veterinary Use Only

Unit mm



Code	Products Name	Dia	U.P.\$
M0011	X Ray Reference Ball	25mm	75.5



## Orthopedic Surgery Planing Ruler





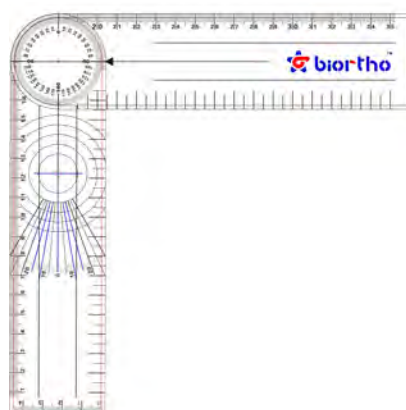

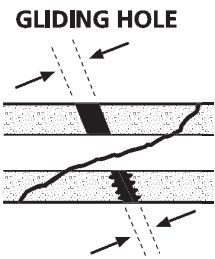

Veterinary Use Only

Unit mm











Code	Products Name	L	U.P.\$
M0010	Orthopedic Surgery Planing Ruler	360mm	11

## Standard Screws, Drill Bits and Tips for Veterinary Use

SCREW DIAMETER (mm)							
Thread Diameter	1.5	2.0	2.4	2.7	3.5	4.5	5.5
Screw Type	<b>Cortex</b>						
Vet Part Number Self-Tapping None-Self-Tapping	CSST1505- CSST1520	CSST2006- CSST2024	CSST2408- CSST2426	CSST2710- CSST2734	CSST3512- CSST3560	CSST4520- CSST4580	CSST5524- CSST55100
	CSTT1505- CSTT1520	CSTT2006- CSTT2026	CSTT2408- CSTT2430	CSTT2710- CSTT2734	CSTT3512- CSTT3560		
DRILL BIT and TAP DIAMETER(mm)							
Drill Bit for Gliding Hole	1.5	2.0	2.4	2.7	3.5	4.5	5.5
<b>GLIDING HOLE</b>  <b>THREADED HOLE</b>							
Drill Bit for Threaded Hole	1.1	1.5	1.8	2.0	2.5	3.2	4.0
Tap Catalog Number	1.5 (100161)	2.0 (100162)	2.4 (100164)	2.7 (100165)	3.5 (100166)	4.5 (100168)	5.5
Drive Type	1.5mm Hexagonal	1.5mm Hexagonal	1.5mm Hexagonal	2.5mm Hexagonal	2.5mm Hexagonal	3.5mm Hexagonal	3.5mm Hexagonal
	T4 Torx	T6 Torx	T8 Torx	T8 Torx	T15 Torx		

## Locking Screws and Drill Bits for Veterinary Use SCREW DIAMETER(mm)

SCREW DIAMETER (mm)								
Thread Diameter	1.2	1.5	2.0	2.4	2.7	3.0	3.5	5.0
Screw Type	<b>Locking Head</b>							
Vet Part Number None-Self-Tapping	LS1204-LS1212	LS1506-LS1520	LS2006-LS2026	LS2408-LS2430	LS2710-LS2734	LS3010-LS3040	LS3510-LS3560	LS5014-LS5090
DRILL BIT DIAMETER(mm)								
								
Drill Bit for Threaded Hole	0.8	1.1	1.5	1.8	2.0	2.5	2.8	4.3
Drive Type	T4 Torx	T4 Torx	T6 Torx	T8 Torx		T10 Torx	T15 Torx	T25 Torx

# Cortex Screws

Veterinary Use Only

Stainless Steel 316LVM

## 1.5mm Cortex Self Tapping Screws, 1.5mm Hexagonal

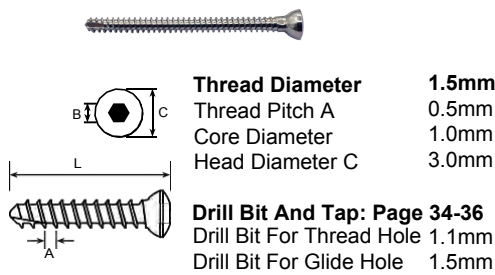

Code	L	U.P.\$
CSST1505	5mm	2.4
CSST1506	6mm	2.4
CSST1507	7mm	2.4
CSST1508	8mm	2.7
CSST1509	9mm	2.7
CSST1510	10mm	2.7

Code	L	U.P.\$
CSST1511	11mm	3.2
CSST1512	12mm	3.2
CSST1514	14mm	3.2
CSST1516	16mm	3.9
CSST1518	18mm	3.9
CSST1520	20mm	3.9

## 2.0mm Cortex Self Tapping Screws, 1.5mm Hexagonal

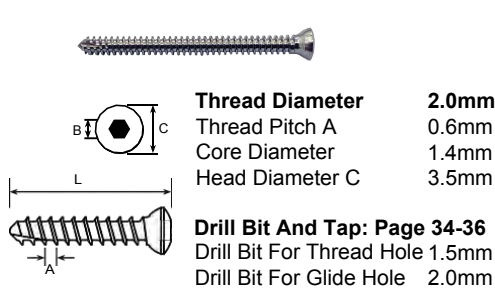

Code	L	U.P.\$
CSST2006	6mm	2.4
CSST2007	7mm	2.4
CSST2008	8mm	2.4
CSST2009	9mm	2.9
CSST2010	10mm	2.9
CSST2012	12mm	2.9

Code	L	U.P.\$
CSST2014	14mm	3.2
CSST2016	16mm	3.2
CSST2018	18mm	3.2
CSST2020	20mm	3.9
CSST2022	22mm	3.9
CSST2024	24mm	3.9
CSST2026	26mm	3.9

## 2.4mm Cortex Self Tapping Screws, 1.5mm Hexagonal

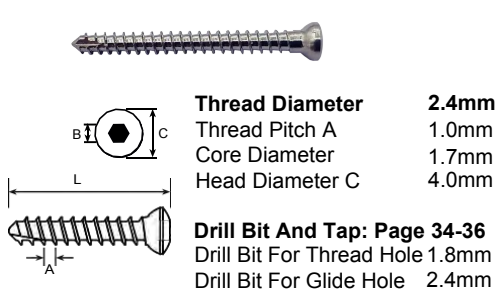

Code	L	U.P.\$
CSST2408	8mm	2.9
CSST2410	10mm	2.9
CSST2412	12mm	2.9
CSST2414	14mm	3.5
CSST2416	16mm	3.5
CSST2418	18mm	3.5

Code	L	U.P.\$
CSST2420	20mm	4
CSST2422	22mm	4
CSST2424	24mm	4
CSST2426	26mm	4.5
CSST2428	28mm	4.5
CSST2430	30mm	4.5

## 2.7mm Cortex Self Tapping Screws, 2.5mm Hexagonal

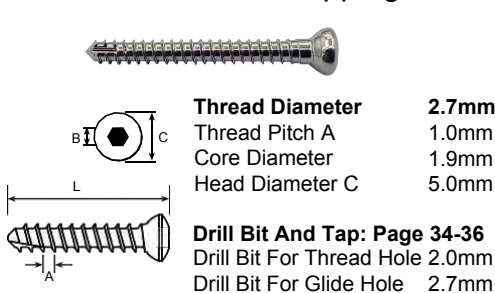

Code	L	U.P.\$
CSST2708	8mm	3.2
CSST2710	10mm	3.2
CSST2712	12mm	3.2
CSST2714	14mm	3.2
CSST2716	16mm	3.7
CSST2718	18mm	3.7
CSST2720	20mm	3.7
CSST2722	22mm	4.2
CSST2724	24mm	4.2

Code	L	U.P.\$
CSST2726	26mm	4.2
CSST2728	28mm	4.8
CSST2730	30mm	4.8
CSST2732	32mm	4.8
CSST2734	34mm	4.8
CSST2736	36mm	5.6
CSST2738	38mm	5.6
CSST2740	40mm	5.6

### 3.5mm Cortex Self Tapping Screws, 2.5mm Hexagonal

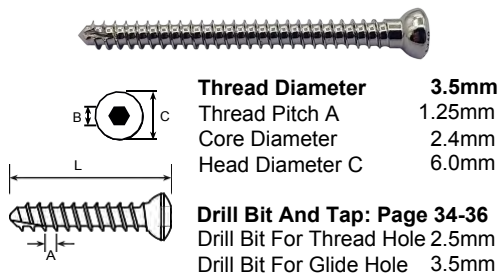

Code	L	U.P.\$
CSST3512	12mm	3.2
CSST3514	14mm	3.2
CSST3516	16mm	3.2
CSST3518	18mm	3.9
CSST3520	20mm	3.9
CSST3522	22mm	3.9
CSST3524	24mm	4.4
CSST3526	26mm	4.4
CSST3528	28mm	4.4
CSST3530	30mm	4.8

Code	L	U.P.\$
CSST3532	32mm	4.8
CSST3534	34mm	4.8
CSST3536	36mm	5.5
CSST3538	38mm	5.5
CSST3540	40mm	6.1
CSST3545	45mm	6.1
CSST3550	50mm	6.8
CSST3555	55mm	6.8
CSST3560	60mm	7.4

### 4.5mm Cortex Self Tapping Screws, 3.5mm Hexagonal

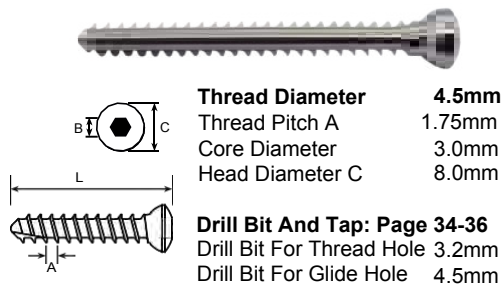

Code	L	U.P.\$
CSST4520	20mm	3.9
CSST4522	22mm	3.9
CSST4524	24mm	3.9
CSST4526	26mm	3.9
CSST4528	28mm	4.5
CSST4530	30mm	4.5
CSST4532	32mm	4.5
CSST4534	34mm	4.5
CSST4536	36mm	5.2
CSST4538	38mm	4.5
CSST4540	40mm	4.5
CSST4542	42mm	4.5
CSST4544	44mm	5.8

Code	L	U.P.\$
CSST4546	46mm	5.8
CSST4548	48mm	5.8
CSST4550	50mm	5.8
CSST4552	52mm	6.5
CSST4554	54mm	6.5
CSST4556	56mm	6.5
CSST4558	58mm	6.5
CSST4560	60mm	7.3
CSST4565	65mm	7.3
CSST4570	70mm	7.3
CSST4575	75mm	7.3
CSST4580	80mm	7.3

### 5.5mm Cortex Self Tapping Screws, 3.5mm Hexagonal



Code	L	U.P.\$
CSST5524	24mm	8.1
CSST5526	26mm	8.1
CSST5528	28mm	8.1
CSST5530	30mm	8.9
CSST5532	32mm	8.9
CSST5534	34mm	8.9
CSST5536	36mm	9.7
CSST5538	38mm	9.7
CSST5540	40mm	9.7
CSST5542	42mm	10.5
CSST5544	44mm	10.5
CSST5546	46mm	10.5

Code	L	U.P.\$
CSST5548	48mm	11.3
CSST5550	50mm	11.3
CSST5552	52mm	11.3
CSST5554	54mm	12.1
CSST5556	56mm	12.1
CSST5558	58mm	12.1
CSST5560	60mm	12.9
CSST5564	64mm	12.9
CSST5570	70mm	12.9
CSST5580	80mm	14.5
CSST5590	90mm	14.5
CSST55100	100mm	14.5

# Cancellous Screws

Veterinary Use Only

Stainless Steel 316LVM

## 2.2mm Cancellous Screws-Full Thread, 1.5mm Hexagonal

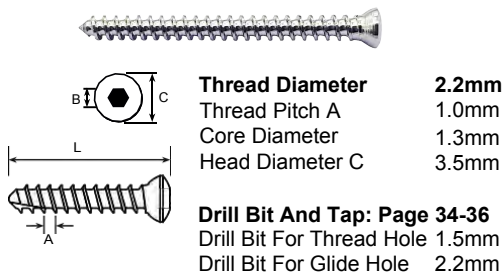

Code	L	U.P.\$
CAN2206	6mm	4
CAN2208	8mm	4
CAN2210	10mm	4
CAN2212	12mm	4.5
CAN2214	14mm	4.5
CAN2216	16mm	4.5

Code	L	U.P.\$
CAN2218	18mm	4.8
CAN2220	20mm	4.8
CAN2222	22mm	4.8
CAN2224	24mm	5.5
CAN2226	26mm	5.5
CAN2228	28mm	5.5

## 2.2mm Cancellous Screws-1/3Partial Thread, 1.5mm Hexagonal



Code	L	U.P.\$
CAN2212H	12mm	6.5
CAN2214H	14mm	6.5
CAN2216H	16mm	6.5
CAN2218H	18mm	7.3
CAN2220H	20mm	7.3

Code	L	U.P.\$
CAN2222H	22mm	7.3
CAN2224H	24mm	8.1
CAN2226H	26mm	8.1
CAN2228H	28mm	8.1
CAN2230H	30mm	8.1

## 3.0mm Cancellous Screws-Full Thread, 2.5mm Hexagonal

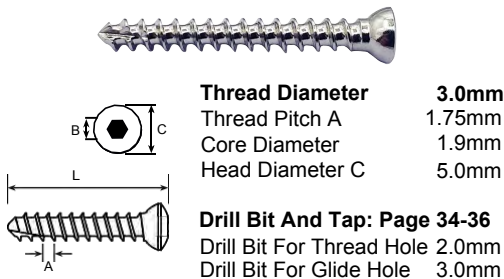

Code	L	U.P.\$
CAN3010	10mm	4
CAN3012	12mm	4
CAN3014	14mm	4
CAN3016	16mm	4
CAN3018	18mm	4
CAN3020	20mm	4.5
CAN3022	22mm	4.5

Code	L	U.P.\$
CAN3024	24mm	4.5
CAN3026	26mm	5.2
CAN3028	28mm	5.2
CAN3030	30mm	5.2
CAN3032	32mm	5.6
CAN3034	34mm	5.6
CAN3036	36mm	5.6

## 3.0mm Cancellous Screws-1/3Partial Thread, 2.5mm Hexagonal

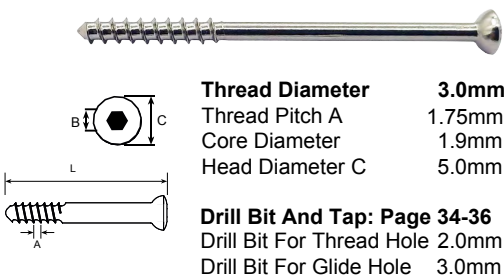

Code	L	U.P.\$
CAN3016H	16mm	5.6
CAN3018H	18mm	5.6
CAN3020H	20mm	5.6
CAN3022H	22mm	6.5
CAN3024H	24mm	6.5
CAN3026H	26mm	6.5
CAN3028H	28mm	7.3

Code	L	U.P.\$
CAN3030H	30mm	7.3
CAN3032H	32mm	7.3
CAN3034H	34mm	7.3
CAN3036H	36mm	8.1
CAN3038H	38mm	8.1
CAN3040H	40mm	8.1
CAN3045H	45mm	8.1

### 4.0mm Cancellous Screws-Full Thread, 2.5mm Hexagonal

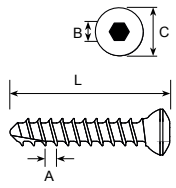

**Thread Diameter** 4.0mm  
**Thread Pitch A** 1.75mm  
**Core Diameter** 2.0mm  
**Head Diameter C** 6.0mm

**Drill Bit And Tap: Page 34-36**  
**Drill Bit For Thread Hole** 2.5mm  
**Drill Bit For Glide Hole** 4.0mm

Code	L	U.P.\$
CNF4014	14mm	4
CNF4016	16mm	4
CNF4018	18mm	4
CNF4020	20mm	4.8
CNF4022	22mm	4.8
CNF4024	24mm	4.8
CNF4026	26mm	5.6
CNF4028	28mm	5.6

Code	L	U.P.\$
CNF4030	30mm	5.6
CNF4032	32mm	6.5
CNF4034	34mm	6.5
CNF4036	36mm	6.5
CNF4038	38mm	7.3
CNF4040	40mm	7.3
CNF4045	45mm	7.3
CNF4050	50mm	7.3

### Washers

Veterinary Use Only

Stainless Steel 316LVM



Code	For Screws	Texture	U.P.\$
PW1115	1.1mm/1.5mm	Stainless	4.2
PW1520	1.5mm/2.0mm	Stainless	4.2
PW2224	2.2mm/2.4mm	Stainless	4.2
PW2730	2.7mm/3.5mm	Stainless	4.2
PW3540	3.5mm/4.0mm	Stainless	4.2

### AO Standard Cortex Screw

Veterinary Use Only

Stainless Steel 316LVM

### 1.5mm Cortex Self Tapping Screws, T6 Torx

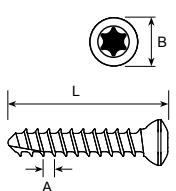

**Thread Diameter** 1.5mm  
**Thread Pitch A** 0.5mm  
**Core Diameter** 1.0mm  
**Head Diameter B** 3.0mm

**Drill Bit And Tap: Page 34-36**  
**Drill Bit For Thread Hole** 1.1mm  
**Drill Bit For Glide Hole** 1.5mm

Code	L	U.P.\$
CSTT1505	5mm	4.2
CSTT1506	6mm	4.5
CSTT1507	7mm	4.8
CSTT1508	8mm	5.2
CSTT1510	10mm	5.5

Code	L	U.P.\$
CSTT1512	12mm	5.8
CSTT1514	14mm	6.1
CSTT1516	16mm	6.5
CSTT1518	18mm	6.8
CSTT1520	20mm	7.1



### 2.0mm Cortex Self Tapping Screws, T6 Torx

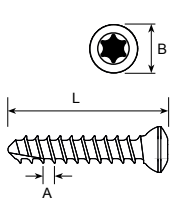

**Thread Diameter** 2.0mm  
 Thread Pitch A 0.8mm  
 Core Diameter 1.4mm  
 Head Diameter B 3.5mm

**Drill Bit And Tap: Page 34-36**  
 Drill Bit For Thread Hole 1.5mm  
 Drill Bit For Glide Hole 2.0mm

Code	L	U.P.\$
CSTT2006	6mm	4.5
CSTT2007	7mm	4.8
CSTT2008	8mm	5.2
CSTT2009	9mm	5.5
CSTT2010	10mm	5.8
CSTT2012	12mm	6.1
CSTT2014	14mm	6.5

Code	L	U.P.\$
CSTT2016	16mm	6.8
CSTT2018	18mm	7.1
CSTT2020	20mm	7.4
CSTT2022	22mm	7.7
CSTT2024	24mm	8.1
CSTT2026	26mm	8.4

### 2.4mm Cortex Self Tapping Screws, T8 Torx

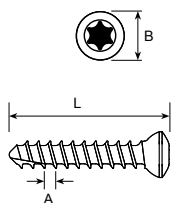

**Thread Diameter** 2.4mm  
 Thread Pitch A 1.0mm  
 Core Diameter 1.7mm  
 Head Diameter B 4.0mm

**Drill Bit And Tap: Page 34-36**  
 Drill Bit For Thread Hole 1.8mm  
 Drill Bit For Glide Hole 2.4mm

Code	L	U.P.\$
CSTT2408	8mm	5.2
CSTT2410	10mm	5.8
CSTT2412	12mm	6.1
CSTT2414	14mm	6.5
CSTT2416	16mm	6.8
CSTT2418	18mm	7.1

Code	L	U.P.\$
CSTT2420	20mm	7.4
CSTT2422	22mm	7.7
CSTT2424	24mm	8.1
CSTT2426	26mm	8.4
CSTT2428	28mm	8.7
CSTT2430	30mm	9

### 2.7mm Cortex Self Tapping Screws, T8 Torx

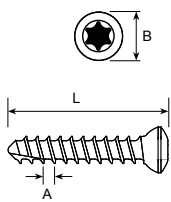

**Thread Diameter** 2.7mm  
 Thread Pitch A 1.0mm  
 Core Diameter 1.9mm  
 Head Diameter B 5.0mm

**Drill Bit And Tap: Page 34-36**  
 Drill Bit For Thread Hole 2.0mm  
 Drill Bit For Glide Hole 2.7mm

Code	L	U.P.\$
CSTT2708	8mm	5.2
CSTT2710	10mm	5.8
CSTT2712	12mm	6.1
CSTT2714	14mm	6.5
CSTT2716	16mm	6.8
CSTT2718	18mm	7.1
CSTT2720	20mm	7.4
CSTT2722	22mm	7.7
CSTT2724	24mm	8.1

Code	L	U.P.\$
CSTT2726	26mm	8.4
CSTT2728	28mm	8.7
CSTT2730	30mm	9
CSTT2732	32mm	9.4
CSTT2734	34mm	9.7
CSTT2736	36mm	10
CSTT2738	38mm	10.3
CSTT2740	40mm	10.6

### 3.5mm Cortex Self Tapping Screws, T15 Torx

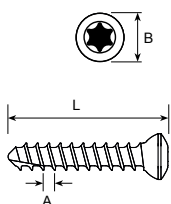

**Thread Diameter** 3.5mm  
 Thread Pitch A 1.25mm  
 Core Diameter 2.4mm  
 Head Diameter B 6.0mm

**Drill Bit And Tap: Page 34-36**  
 Drill Bit For Thread Hole 2.5mm  
 Drill Bit For Glide Hole 3.5mm

Code	L	U.P.\$
CSTT3512	12mm	6.1
CSTT3514	14mm	6.5
CSTT3516	16mm	6.8
CSTT3518	18mm	7.1
CSTT3520	20mm	7.4
CSTT3522	22mm	7.7
CSTT3524	24mm	8.1
CSTT3526	26mm	8.4
CSTT3528	28mm	8.7
CSTT3530	30mm	9

Code	L	U.P.\$
CSTT3532	32mm	9.4
CSTT3534	34mm	9.7
CSTT3536	36mm	10
CSTT3538	38mm	10.3
CSTT3540	40mm	10.6
CSTT3545	45mm	11.5
CSTT3550	50mm	12.3
CSTT3555	55mm	13.1
CSTT3560	60mm	13.9

AO Standard Locking Screw

Veterinary Use Only

Stainless Steel 316LVM

1.2mm Titanium Locking Self Tapping Screws, T4 Torx



**Thread Diameter** 1.2mm  
**Thread Pitch A** 0.6mm  
**Core Diameter** 1.1mm  
**Head Diameter B** 2.2mm

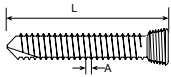

**Drill Bit And Tap: Page 34-36**

Code	L	U.P.\$
LS1204	4mm	10.3
LS1205	5mm	10.6
LS1206	6mm	11
LS1207	7mm	11.3

Code	L	U.P.\$
LS1208	8mm	11.6
LS1209	9mm	11.9
LS1210	10mm	12.3
LS1212	12mm	12.6

1.5mm Titanium Locking Self Tapping Screws, T4 Torx



**Thread Diameter** 1.5mm  
**Thread Pitch A** 0.6mm  
**Core Diameter** 1.1mm  
**Head Diameter B** 2.2mm

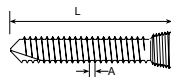

**Drill Bit And Tap: Page 34-36**

Code	L	U.P.\$
LS1506	6mm	11
LS1507	7mm	11.3
LS1508	8mm	11.6
LS1509	9mm	11.9
LS1510	10mm	12.3

Code	L	U.P.\$
LS1512	12mm	12.6
LS1514	14mm	12.9
LS1516	16mm	13.2
LS1518	18mm	13.5
LS1520	20mm	13.9

2.0mm Locking Self Tapping Screws, T6 Torx



**Thread Diameter** 2.0mm  
**Thread Pitch A** 0.75mm  
**Core Diameter** 1.4mm  
**Head Diameter B** 3.0mm

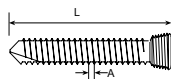

**Drill Bit And Tap: Page 34-36**

Code	L	U.P.\$
LS2006	6mm	8.7
LS2007	7mm	9
LS2008	8mm	9.4
LS2009	9mm	9.7
LS2010	10mm	10
LS2012	12mm	10.3
LS2014	14mm	10.6

Code	L	U.P.\$
LS2016	16mm	11
LS2018	18mm	11.3
LS2020	20mm	11.6
LS2022	22mm	11.9
LS2024	24mm	12.3
LS2026	26mm	12.6

2.4mm Locking Self Tapping Screws, T8 Torx



**Thread Diameter** 2.4mm  
**Thread Pitch A** 0.6mm  
**Core Diameter** 1.9mm  
**Head Diameter B** 3.5mm

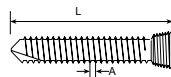

**Drill Bit And Tap: Page 34-36**

Code	L	U.P.\$
LS2408	8mm	9.4
LS2410	10mm	10
LS2412	12mm	10.3
LS2414	14mm	10.6
LS2416	16mm	11
LS2418	18mm	11.3

Code	L	U.P.\$
LS2420	20mm	11.6
LS2422	22mm	11.9
LS2424	24mm	12.3
LS2426	26mm	12.6
LS2428	28mm	12.9
LS2430	30mm	13.2

### 2.7mm Locking Self Tapping Screws, T8 Torx



**Thread Diameter** 2.7mm  
**Thread Pitch A** 0.6mm  
**Core Diameter** 2.1mm  
**Head Diameter B** 3.5mm

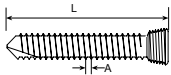

**Drill Bit And Tap: Page 34-36**

Code	L	U.P.\$
LS2710	10mm	10
LS2712	12mm	10.3
LS2714	14mm	10.6
LS2716	16mm	11
LS2718	18mm	11.3
LS2720	20mm	11.6
LS2722	22mm	11.9

Code	L	U.P.\$
LS2724	24mm	12.3
LS2726	26mm	12.6
LS2728	28mm	12.9
LS2730	30mm	13.2
LS2732	32mm	13.5
LS2734	34mm	13.9

### 3.0mm Locking Self Tapping Screws, T10 Torx



**Thread Diameter** 3.0mm  
**Thread Pitch A** 0.8mm  
**Core Diameter** 2.4mm  
**Head Diameter B** 4.0mm

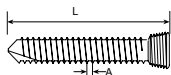

**Drill Bit And Tap: Page 34-36**

Code	L	U.P.\$
LS3010	10mm	10
LS3012	12mm	10.3
LS3014	14mm	10.6
LS3016	16mm	11
LS3018	18mm	11.3
LS3020	20mm	11.6
LS3022	22mm	11.9
LS3024	24mm	12.3

Code	L	U.P.\$
LS3026	26mm	12.6
LS3028	28mm	12.9
LS3030	30mm	13.2
LS3032	32mm	13.5
LS3034	34mm	13.9
LS3036	36mm	14.2
LS3038	38mm	14.5
LS3040	40mm	14.8

### 3.5mm Locking Self Tapping Screws, T15 Torx



**Thread Diameter** 3.5mm  
**Thread Pitch A** 1.0mm  
**Core Diameter** 2.9mm  
**Head Diameter B** 3.5mm

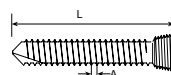

**Drill Bit And Tap: Page 34-36**

Code	L	U.P.\$
LS3510	10mm	10
LS3512	12mm	10.3
LS3514	14mm	10.6
LS3516	16mm	11
LS3518	18mm	11.3
LS3520	20mm	11.6
LS3522	22mm	11.9
LS3524	24mm	12.3
LS3526	26mm	12.6
LS3528	28mm	12.9

Code	L	U.P.\$
LS3530	30mm	13.2
LS3532	32mm	13.5
LS3534	34mm	13.9
LS3536	36mm	14.2
LS3538	38mm	14.5
LS3540	40mm	14.8
LS3545	45mm	15.6
LS3550	50mm	16.6
LS3555	55mm	17.4
LS3560	60mm	18.2

### 5.0mm Locking Self Tapping Screws, T25 Torx



**Thread Diameter** 5.0mm  
**Thread Pitch A** 1.0mm  
**Core Diameter** 4.4mm  
**Head Diameter B** 3.5mm

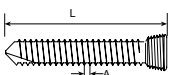

**Drill Bit And Tap: Page 34-36**

Code	L	U.P.\$
LS5014	14mm	13.9
LS5016	16mm	14.2
LS5018	18mm	14.5
LS5020	20mm	14.8
LS5022	22mm	15.2
LS5024	24mm	15.5
LS5026	26mm	15.8
LS5028	28mm	16.1
LS5030	30mm	16.5
LS5032	32mm	16.8
LS5034	34mm	17.1
LS5036	36mm	17.4
LS5038	38mm	17.7
LS5040	40mm	18.1

Code	L	U.P.\$
LS5042	42mm	18.4
LS5044	44mm	18.7
LS5046	46mm	19
LS5048	48mm	19.4
LS5050	50mm	19.7
LS5055	55mm	21.3
LS5060	60mm	22.9
LS5065	65mm	24.5
LS5070	70mm	26.1
LS5075	75mm	27.7
LS5080	80mm	29.4
LS5085	85mm	31
LS5090	90mm	32.6

Swiss Titanium Cortex Screw

Veterinary Use Only

Titanium Grade 5

ø1.1mm Cortex Screw Self-tapping, 1.5 Cruciform Matching with ALPS 3.5/4.2



Code	L	U.P.\$	Code	L	U.P.\$
TCS1104	4mm	6.8	TCS1108	8mm	7.7
TCS1105	5mm	6.8	TCS1109	9mm	7.7
TCS1106	6mm	7.4	TCS1110	10mm	8.1
TCS1107	7mm	7.4	TCS1112	12mm	8.1

ø1.5mm Cortex Screw Self-tapping, T6 Torx Matching with ALPS 5/6.5 and TTA System



Code	L	U.P.\$	Code	L	U.P.\$
TCS1506	6mm	4.2	TCS1518	18mm	5.5
TCS1507	7mm	4.2	TCS1520	20mm	6.1
TCS1508	8mm	4.2	TCS1522	22mm	6.1
TCS1509	9mm	4.8	TCS1524	24mm	6.1
TCS1510	10mm	4.8	TCS1526	26mm	6.8
TCS1512	12mm	4.8	TCS1528	28mm	6.8
TCS1514	14mm	5.5	TCS1530	30mm	6.8
TCS1516	16mm	5.5			

ø2.0mm Cortex Screw Self-tapping, T6 Torx Matching with ALPS 5/6.5 and TTA System



Code	L	U.P.\$	Code	L	U.P.\$
TCS2006	6mm	4.2	TCS2016	16mm	5.5
TCS2007	7mm	4.2	TCS2018	18mm	5.5
TCS2008	8mm	4.2	TCS2020	20mm	5.5
TCS2010	10mm	4.8	TCS2022	22mm	6.1
TCS2012	12mm	4.8	TCS2024	24mm	6.1
TCS2014	14mm	4.8	TCS2026	26mm	6.1

ø2.4mm Cortex Screw Self-tapping, T10 Torx Matching with ALPS 7.5/8.5 and TTA System



Code	L	U.P.\$	Code	L	U.P.\$
TCS2408	8mm	4.2	TCS2422	22mm	5.5
TCS2410	10mm	4.2	TCS2424	24mm	5.5
TCS2412	12mm	4.2	TCS2426	26mm	5.5
TCS2414	14mm	4.2	TCS2428	28mm	6.1
TCS2416	16mm	4.8	TCS2430	30mm	6.1
TCS2418	18mm	4.8	TCS2432	32mm	6.1
TCS2420	20mm	4.8			

ø2.7mm Cortex Screw Self-tapping, T10 Torx Matching with ALPS 10/11.5 and TTA System



Code	L	U.P.\$	Code	L	U.P.\$
TCS2710	10mm	4.2	TCS2724	24mm	5.5
TCS2712	12mm	4.2	TCS2726	26mm	5.5
TCS2714	14mm	4.2	TCS2728	28mm	6.1
TCS2716	16mm	4.8	TCS2730	30mm	6.1
TCS2718	18mm	4.8	TCS2732	32mm	6.1
TCS2720	20mm	4.8	TCS2734	34mm	6.8
TCS2722	22mm	5.5			

ø3.5mm Cortex Screw Self-tapping, T15 Torx Matching with TTA System



Code	L	U.P.\$
TCS3512	12mm	4.2
TCS3514	14mm	4.2
TCS3516	16mm	4.8
TCS3518	18mm	4.8
TCS3520	20mm	4.8
TCS3522	22mm	5.5
TCS3524	24mm	5.5
TCS3526	26mm	5.5
TCS3528	28mm	6.1
TCS3530	30mm	6.1

Code	L	U.P.\$
TCS3532	32mm	6.1
TCS3534	34mm	6.8
TCS3536	36mm	6.8
TCS3538	38mm	6.8
TCS3540	40mm	7.4
TCS3545	45mm	7.4
TCS3550	50mm	7.4
TCS3555	55mm	8.1
TCS3560	60mm	8.1

Swiss Titanium Locking Screw

Veterinary Use Only

Titanium Grade 5

B1.6mm Locking Self Tapping Screws, 1.5 Cruciform Matching with ALPS3.5/4.2



Code	L	U.P.\$
B1600	1.5mm Plug	10.6
B1604	4mm	9
B1605	5mm	9.4
B1606	6mm	9.7
B1607	7mm	10
B1608	8mm	10.3
B1610	10mm	10.6

B2.4mm Locking Self Tapping Screws, T6 Torx Matching with ALPS 5/6.5



Code	L	U.P.\$
B2400	2mm Plug	10.3
B2405	5mm	9
B2406	6mm	9.4
B2408	8mm	9.7
B2410	10mm	10
B2412	12mm	10.3

Code	L	U.P.\$
B2414	14mm	10.6
B2416	16mm	11
B2418	18mm	11.3
B2420	20mm	11.6
B2422	22mm	11.9
B2424	24mm	12.3

B3.2mm Locking Self Tapping Screws, T10 Torx Matching with ALPS 7.5/8.5



Code	L	U.P.\$
B3200	2.5mm Plug	10.6
B3208	8mm	9
B3210	10mm	9.4
B3212	12mm	9.7
B3214	14mm	10
B3216	16mm	10.3
B3218	18mm	10.6
B3220	20mm	11

Code	L	U.P.\$
B3222	22mm	11.3
B3224	24mm	11.6
B3226	26mm	11.9
B3228	28mm	12.3
B3230	30mm	12.6
B3232	32mm	12.9
B3234	34mm	13.2

B4.0mm Locking Self Tapping Screws, T10 Torx Matching with ALPS 10/11.5



Code	L	U.P.\$
B4000	4mm Plug	10.6
B4010	10mm	9
B4012	12mm	9.4
B4014	14mm	9.7
B4016	16mm	10
B4018	18mm	10.3
B4020	20mm	10.6
B4022	22mm	11
B4024	24mm	11.3

Code	L	U.P.\$
B4026	26mm	11.6
B4028	28mm	11.9
B4030	30mm	12.3
B4032	32mm	12.6
B4034	34mm	12.9
B4036	36mm	13.2
B4038	38mm	13.5
B4040	40mm	13.9

## Italy Titanium Locking Screw

Veterinary Use Only

Titanium Grade 5

### ø1.7mm Micro Auto Locking T4 Torx



Code	L	U.P.\$
V2356	6mm	11
V2357	7mm	11.3
V2358	8mm	11.6
V2359	9mm	11.9

Code	L	U.P.\$
V2360	10mm	12.3
V2362	12mm	12.6
V2364	14mm	12.9

### ø1.9mm Auto Locking Screw T8 Torx



Code	L	U.P.\$
V2406	6mm	11
V2407	7mm	11.3
V2408	8mm	11.6
V2409	9mm	11.9

Code	L	U.P.\$
V2410	10mm	12.3
V2412	12mm	12.6
V2414	14mm	12.9

### ø2.5mm Auto Locking Screw T8 Torx



Code	L	U.P.\$
V2510	10mm	12.3
V2512	12mm	12.6
V2514	14mm	12.9
V2516	16mm	13.2
V2518	18mm	13.5
V2520	20mm	13.9

Code	L	U.P.\$
V2522	22mm	14.2
V2524	24mm	14.5
V2526	26mm	14.8
V2528	28mm	15.2
V2530	30mm	15.5

### ø3.0mm Auto Locking Screw T10 Torx



Code	L	U.P.\$
V2610	10mm	12.3
V2612	12mm	12.6
V2614	14mm	12.9
V2616	16mm	13.2
V2618	18mm	13.5
V2620	20mm	13.9

Code	L	U.P.\$
V2622	22mm	14.2
V2624	24mm	14.5
V2626	26mm	14.8
V2628	28mm	15.2
V2630	30mm	15.5

### ø3.5mm Auto Locking Screw T10 Torx



Code	L	U.P.\$
V3512	12mm	12.6
V3514	14mm	12.9
V3516	16mm	13.2
V3518	18mm	13.5
V3520	20mm	13.9
V3522	22mm	14.2
V3524	24mm	14.5
V3526	26mm	14.8
V3528	28mm	15.2
V3530	30mm	15.5
V3532	32mm	15.8

Code	L	U.P.\$
V3534	34mm	16.1
V3536	36mm	16.5
V3538	38mm	16.8
V3542	42mm	17.1
V3546	46mm	17.7
V3550	50mm	18.4
V3554	54mm	19
V3558	58mm	19.7
V3562	62mm	20
V3566	66mm	20.6
V3570	70mm	21

### Auto Locking Sleeve



Code	Describe	U.P.\$
V121	1.7mm Auto Locking Sleeve	12.9
V120	1.9/2.5mm Auto Locking Sleeve	12.9
V130	3.0/3.5mm Auto Locking Sleeve	12.9

Screw Caddy

Veterinary Use Only

BIORTHO ALPS Screws Caddy

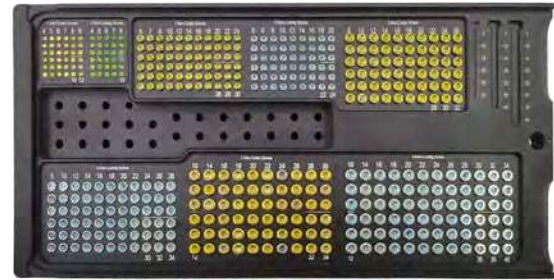
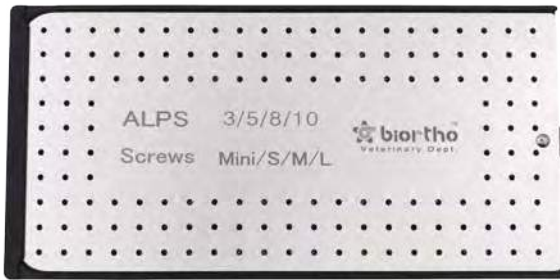

Code	Specification	U.P.\$
ALPS00	225X115X50mm	368

1.1mm Cortex Screw Self tapping 1.5mm Cruciform

Code	L	Holes
TCS1104	4mm	6
TCS1105	5mm	6
TCS1106	6mm	6
TCS1107	7mm	6
TCS1108	8mm	3
TCS1109	9mm	3
TCS1110	10mm	3
TCS1112	12mm	3

2.4mm Locking Self Tapping Screws T6 Torx

Code	L	Holes
B2405	5mm	6
B2406	6mm	6
B2408	8mm	6
B2410	10mm	6
B2412	12mm	6
B2414	14mm	6
B2416	16mm	6
B2418	18mm	3
B2420	20mm	3
B2422	22mm	3
B2424	24mm	3

2.7mm Cortex Screw Self tapping T10 Torx

Code	L	Holes
TCS2710	10mm	3
TCS2712	12mm	3
TCS2714	14mm	6
TCS2716	16mm	6
TCS2718	18mm	6
TCS2720	20mm	6
TCS2722	22mm	6
TCS2724	24mm	6
TCS2726	26mm	6
TCS2728	28mm	3
TCS2730	30mm	3
TCS2732	32mm	3
TCS2734	34mm	3

1.6mm Locking Self Tapping Screws 1.5mm Cruciform

Code	L	Holes
B1604	4mm	6
B1605	5mm	6
B1606	6mm	6
B1607	7mm	6
B1608	8mm	3
B1610	10mm	3

2.4mm Cortex Screw Self tapping T10 Torx

Code	L	Holes
TCS2408	8mm	6
TCS2410	10mm	6
TCS2412	12mm	6
TCS2414	14mm	6
TCS2416	16mm	6
TCS2418	18mm	6
TCS2420	20mm	6
TCS2422	22mm	3
TCS2424	24mm	3
TCS2426	26mm	3
TCS2428	28mm	3
TCS2430	30mm	3
TCS2432	32mm	3

4.0mm Locking Self Tapping Screws T10 Torx

Code	L	Holes
B4010	10mm	3
B4012	12mm	3
B4014	14mm	6
B4016	16mm	6
B4018	18mm	6
B4020	20mm	6
B4022	22mm	6
B4024	24mm	6
B4026	26mm	6
B4028	28mm	6
B4030	30mm	3
B4032	32mm	3
B4034	34mm	3
B4036	36mm	3
B4038	38mm	3
B4040	40mm	3

1.5mm Cortex Screw Self tapping T6 Torx

Code	L	Holes
TCS1506	6mm	6
TCS1507	7mm	6
TCS1508	8mm	6
TCS1510	10mm	6
TCS1512	12mm	6
TCS1514	14mm	6
TCS1516	16mm	6
TCS1518	18mm	6
TCS1520	20mm	3
TCS1522	22mm	3
TCS1524	24mm	3
TCS1526	26mm	3
TCS1528	28mm	3
TCS1530	30mm	3

B3.2mm Locking Self Tapping Screws T10 Torx

Code	L	Holes
B3208	8mm	6
B3210	10mm	6
B3212	12mm	6
B3214	14mm	6
B3216	16mm	6
B3218	18mm	6
B3220	20mm	6
B3222	22mm	6
B3224	24mm	3
B3226	26mm	3
B3228	28mm	3
B3230	30mm	3
B3232	32mm	3
B3234	34mm	3

BIORTHO Standard Screw Caddy(1.5/2.0/2.4/2.7/3.5mm)



Code	Specification	U.P.\$
CSTT00	225X115X50mm	368

1.5mm Cortex Screw Self tapping T6 Torx

Code	L	Holes
CSTT1505	5mm	8
CSTT1506	6mm	8
CSTT1507	7mm	8
CSTT1508	8mm	8
CSTT1510	10mm	8
CSTT1512	12mm	8
CSTT1514	14mm	3
CSTT1516	16mm	3
CSTT1518	18mm	3
CSTT1520	20mm	3

2.0mm Cortex Screw Self tapping T6 Torx

Code	L	Holes
CSTT2006	6mm	8
CSTT2007	7mm	8
CSTT2008	8mm	8
CSTT2009	9mm	8
CSTT2010	10mm	8
CSTT2012	12mm	8
CSTT2014	14mm	8
CSTT2016	16mm	8
CSTT2018	18mm	8
CSTT2020	20mm	3
CSTT2022	22mm	3
CSTT2024	24mm	3
CSTT2026	26mm	3

2.4mm Cortex Screw Self tapping T8 Torx

Code	L	Holes
CSTT2408	8mm	8
CSTT2410	10mm	8
CSTT2412	12mm	8
CSTT2414	14mm	8
CSTT2416	16mm	8
CSTT2418	18mm	8
CSTT2420	20mm	8
CSTT2422	22mm	8
CSTT2424	24mm	3
CSTT2426	26mm	3
CSTT2428	28mm	3
CSTT2430	30mm	3

2.7mm Cortex Screw Self tapping T8 Torx

Code	L	Holes
CSTT2708	8mm	6
CSTT2710	10mm	6
CSTT2712	12mm	6
CSTT2714	14mm	6
CSTT2716	16mm	6
CSTT2718	18mm	6
CSTT2720	20mm	6
CSTT2722	22mm	6
CSTT2724	24mm	6
CSTT2726	26mm	6
CSTT2728	28mm	3
CSTT2730	30mm	3
CSTT2732	32mm	3
CSTT2734	34mm	3

3.5mm Cortex Screw Self tapping T15 Torx

Code	L	Holes
CSTT3512	12mm	6
CSTT3514	14mm	6
CSTT3516	16mm	6
CSTT3518	18mm	6
CSTT3520	20mm	6
CSTT3522	22mm	6
CSTT3524	24mm	6
CSTT3526	26mm	6
CSTT3528	28mm	6
CSTT3530	30mm	6
CSTT3532	32mm	6
CSTT3534	34mm	3
CSTT3536	36mm	3
CSTT3538	38mm	3
CSTT3540	40mm	3



BIORTHO Aluminum Screw Caddy(1.5/2.0/2.4/2.7/3.5mm)

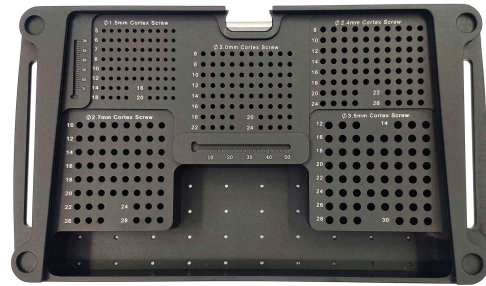

Code	Specification	U.P.\$
000005	240X140X35mm	261.3

1.5mm Cortex Self Tapping Screws 1.5mm hexagonal

Code	L	Holes
CSST1505	5mm	10
CSST1506	6mm	10
CSST1507	7mm	10
CSST1508	8mm	10
CSST1510	10mm	10
CSST1512	12mm	10
CSST1514	14mm	4
CSST1516	16mm	4
CSST1518	18mm	4
CSST1520	20mm	4

2.0mm Cortex Self Tapping Screws 1.5mm hexagonal

Code	L	Holes
CSST2006	6mm	10
CSST2008	8mm	10
CSST2010	10mm	10
CSST2012	12mm	10
CSST2014	14mm	10
CSST2016	16mm	10
CSST2018	18mm	4
CSST2020	20mm	4
CSST2022	22mm	4
CSST2024	24mm	4

2.4mm Cortex Self Tapping Screws 1.5mm hexagonal

Code	L	Holes
CSST2408	8mm	10
CSST2410	10mm	10
CSST2412	12mm	10
CSST2414	14mm	10
CSST2416	16mm	10
CSST2418	18mm	10
CSST2420	20mm	4
CSST2422	22mm	4
CSST2424	24mm	4
CSST2426	26mm	4

2.7mm Cortex Self Tapping Screws 2.5mm hexagonal

Code	L	Holes
CSST2710	10mm	8
CSST2712	12mm	8
CSST2714	14mm	8
CSST2716	16mm	8
CSST2718	18mm	8
CSST2720	20mm	8
CSST2722	22mm	3
CSST2724	24mm	3
CSST2726	26mm	3
CSST2728	28mm	3

3.5mm Cortex Self Tapping Screws 2.5mm hexagonal

Code	L	Holes
CSST3512	12mm	3
CSST3514	14mm	3
CSST3516	16mm	8
CSST3518	18mm	8
CSST3520	20mm	8
CSST3522	22mm	8
CSST3524	24mm	8
CSST3526	26mm	8
CSST3528	28mm	3
CSST3530	30mm	3

BIORTHO Aluminum Screw Caddy(1.5/2.0/2.2/2.4/2.7/3.0/3.5/4.0mm)



Code	Specification	U.P.\$
000016	270X160X65mm	303.2

1.5mm Cortex Self Tapping Screws 1.5mm hexagonal

Code	L	Holes
CSST1505	5mm	10
CSST1506	6mm	10
CSST1507	7mm	10
CSST1508	8mm	20
CSST1509	9mm	10
CSST1510	10mm	10
CSST1511	11mm	10
CSST1512	12mm	10
CSST1514	14mm	10
CSST1516	16mm	10

2.0mm Cortex Self Tapping Screws 1.5mm hexagonal

Code	L	Holes
CSST2006	6mm	10
CSST2007	7mm	10
CSST2008	8mm	10
CSST2009	9mm	10
CSST2010	10mm	20
CSST2012	12mm	20
CSST2014	14mm	10
CSST2016	16mm	10
CSST2018	18mm	10
CSST2020	20mm	10

2.4mm Cortex Self Tapping Screws 1.5mm hexagonal

Code	L	Holes
CSST2408	8mm	8
CSST2410	10mm	8
CSST2412	12mm	8
CSST2414	14mm	16
CSST2416	16mm	8
CSST2418	18mm	8
CSST2420	20mm	8
CSST2422	22mm	4
CSST2424	24mm	4
CSST2426	26mm	3
CSST2428	28mm	3

2.7mm Cortex Self Tapping Screws 2.5mm hexagonal

Code	L	Holes
CSST2710	10mm	6
CSST2712	12mm	6
CSST2714	14mm	6
CSST2716	16mm	12
CSST2718	18mm	12
CSST2720	20mm	6
CSST2722	22mm	6
CSST2724	24mm	6
CSST2726	26mm	6
CSST2728	28mm	6
CSST2730	30mm	6
CSST2732	32mm	6

3.5mm Cortex Self Tapping Screws 2.5mm hexagonal

Code	L	Holes
CSST3512	12mm	6
CSST3514	14mm	6
CSST3516	16mm	6
CSST3518	18mm	6
CSST3520	20mm	12
CSST3522	22mm	12
CSST3524	24mm	12
CSST3526	26mm	6
CSST3528	28mm	6
CSST3530	30mm	6
CSST3532	32mm	6
CSST3534	34mm	3
CSST3536	36mm	3
CSST3538	38mm	2
CSST3540	40mm	2

2.2mm Cancellous Full Thread Screws 1.5mm hexagonal

Code	L	Holes
CAN2206	6mm	5
CAN2208	8mm	5
CAN2210	10mm	5
CAN2212	12mm	5
CAN2214	14mm	5
CAN2216	16mm	5
CAN2218	18mm	5
CAN2220	20mm	5
CAN2222	22mm	2
CAN2224	24mm	2
CAN2226	26mm	2
CAN2228	28mm	2

2.2mm Cancellous Screws-1/3Partial Thread 1.5mm hexagonal

Code	L	Holes
CAN2212H	12mm	3
CAN2214H	14mm	3
CAN2216H	16mm	3
CAN2218H	18mm	3
CAN2220H	20mm	3
CAN2222H	22mm	3
CAN2224H	24mm	3
CAN2226H	26mm	3
CAN2228H	28mm	3
CAN2230H	30mm	3

3.0mm Cancellous Full Thread Screws 2.5mm hexagonal

Code	L	Holes
CAN3010	10mm	4
CAN3012	12mm	4
CAN3014	14mm	4
CAN3016	16mm	4
CAN3018	18mm	4
CAN3020	20mm	4
CAN3022	22mm	4
CAN3024	24mm	4
CAN3026	26mm	4
CAN3028	28mm	4
CAN3030	30mm	4
CAN3032	32mm	4
CAN3034	34mm	4
CAN3036	36mm	4

4.0mm Cancellous Full Thread Screws 2.5mm hexagonal

Code	L	Holes
CNF4014	14mm	4
CNF4016	16mm	4
CNF4018	18mm	4
CNF4020	20mm	4
CNF4022	22mm	4
CNF4024	24mm	4
CNF4026	26mm	4
CNF4028	28mm	4
CNF4030	30mm	4
CNF4032	32mm	4
CNF4034	34mm	4
CNF4036	36mm	4
CNF4038	38mm	4
CNF4040	40mm	4
CNF4045	45mm	4
CNF4050	50mm	4

Screw Caddy 1.5/2.0/2.4mm



Code	Specification	U.P.\$
MINI.014A	150X95X36mm	67.7

1.5mm Cortex Self Tapping Screws 1.5mm hexagonal		
Code	L	Holes
CSST1505	5mm	5
CSST1506	6mm	5
CSST1507	7mm	5
CSST1508	8mm	5
CSST1510	10mm	5
CSST1512	12mm	5
CSST1514	14mm	5
CSST1516	16mm	5
CSST1518	18mm	5
CSST1520	20mm	5

2.0mm Cortex Self Tapping Screws 1.5mm hexagonal		
Code	L	Holes
CSST2006	6mm	6
CSST2007	7mm	6
CSST2008	8mm	6
CSST2010	10mm	6
CSST2012	12mm	6
CSST2014	14mm	6
CSST2016	16mm	6
CSST2018	18mm	6
CSST2020	20mm	6
CSST2022	22mm	6
CSST2024	24mm	6

2.4mm Cortex Self Tapping Screws 1.5mm hexagonal		
Code	L	Holes
CSST2408	8mm	6
CSST2410	10mm	6
CSST2412	12mm	6
CSST2414	14mm	6
CSST2416	16mm	6
CSST2418	18mm	6
CSST2420	20mm	6
CSST2422	22mm	6
CSST2424	24mm	6
CSST2426	26mm	6
CSST2428	28mm	6

Screw Caddy 1.5/2.0/2.7mm



Code	Specification	U.P.\$
MINI.014B	150X95X36mm	67.7

1.5mm Cortex Self Tapping Screws 1.5mm hexagonal		
Code	L	Holes
CSST1505	5mm	5
CSST1506	6mm	5
CSST1507	7mm	5
CSST1508	8mm	5
CSST1510	10mm	5
CSST1512	12mm	5
CSST1514	14mm	5
CSST1516	16mm	5
CSST1518	18mm	5
CSST1520	20mm	5

2.0mm Cortex Self Tapping Screws 1.5mm hexagonal		
Code	L	Holes
CSST2006	6mm	6
CSST2008	8mm	6
CSST2010	10mm	6
CSST2012	12mm	6
CSST2014	14mm	6
CSST2016	16mm	6
CSST2018	18mm	6
CSST2020	20mm	6
CSST2022	22mm	6
CSST2024	24mm	6
CSST2026	26mm	6

2.7mm Cortex Self Tapping Screws 2.5mm hexagonal		
Code	L	Holes
CSST2710	10mm	6
CSST2712	12mm	6
CSST2714	14mm	6
CSST2716	16mm	6
CSST2718	18mm	6
CSST2720	20mm	6
CSST2722	22mm	6
CSST2724	24mm	6
CSST2726	26mm	6
CSST2728	28mm	6
CSST2730	30mm	6

Screw Caddy 2.7/3.5mm



Code	Specification	U.P.\$
SMALL.028	185X115X60	90.3

2.7mm Cortex Self Tapping Screws 2.5mm hexagonal		
Code	L	Holes
CSST2708	8mm	6
CSST2710	10mm	6
CSST2712	12mm	6
CSST2714	14mm	6
CSST2716	16mm	6
CSST2718	18mm	6
CSST2720	20mm	6
CSST2722	22mm	6
CSST2724	24mm	6
CSST2726	26mm	6
CSST2728	28mm	6
CSST2730	30mm	6
CSST2734	34mm	6
CSST2738	38mm	6

3.5mm Cortex Self Tapping Screws 2.5mm hexagonal		
Code	L	Holes
CSST3510	10mm	6
CSST3512	12mm	6
CSST3514	14mm	6
CSST3516	16mm	6
CSST3518	18mm	6
CSST3520	20mm	6
CSST3522	22mm	6
CSST3524	24mm	6
CSST3526	26mm	6
CSST3528	28mm	6
CSST3530	30mm	6
CSST3532	32mm	6
CSST3534	34mm	8
CSST3536	36mm	6
CSST3538	38mm	6
CSST3540	40mm	6
CSST3545	45mm	6
CSST3550	50mm	6

Locking Screws Caddy 1.5/2.0/2.4mm



Code	Specification	U.P.\$
025.009	180X100X40mm	319.4

1.5mm Titanium Locking Self Tapping Screws T4 Torx		
Code	L	Holes
LS1506	6mm	8
LS1507	7mm	8
LS1508	8mm	8
LS1509	9mm	8
LS1510	10mm	8
LS1512	12mm	8
LS1514	14mm	8
LS1516	16mm	8
LS1518	18mm	4
LS1520	20mm	4

1.5mm Cortex Self Tapping Screws 1.5mm hexagonal		
Code	L	Holes
CSST1506	6mm	6
CSST1507	7mm	6
CSST1508	8mm	6
CSST1509	9mm	6
CSST1510	10mm	6
CSST1512	12mm	6
CSST1514	14mm	6
CSST1516	16mm	6
CSST1518	18mm	3
CSST1520	20mm	3

2.0mm Locking Self Tapping Screws T6 Torx		
Code	L	Holes
LS2006	6mm	8
LS2007	7mm	8
LS2008	8mm	8
LS2009	9mm	8
LS2010	10mm	8
LS2012	12mm	8
LS2014	14mm	8
LS2016	16mm	8
LS2018	18mm	8
LS2020	20mm	4
LS2022	22mm	4
LS2024	24mm	4
LS2026	26mm	4

2.0mm Cortex Self Tapping Screws 1.5mm hexagonal		
Code	L	Holes
CSST2006	6mm	6
CSST2007	7mm	6
CSST2008	8mm	6
CSST2009	9mm	6
CSST2010	10mm	6
CSST2012	12mm	6
CSST2014	14mm	6
CSST2016	16mm	6
CSST2018	18mm	6
CSST2020	20mm	3
CSST2022	22mm	3
CSST2024	24mm	3
CSST2026	26mm	3

2.4mm Locking Self Tapping Screws T8 Torx		
Code	L	Holes
LS2408	8mm	8
LS2410	10mm	8
LS2412	12mm	8
LS2414	14mm	8
LS2416	16mm	8
LS2418	18mm	8
LS2420	20mm	8
LS2422	22mm	8
LS2424	24mm	4
LS2426	26mm	4
LS2428	28mm	4
LS2430	30mm	4

2.4mm Cortex Self Tapping Screws 1.5mm hexagonal		
Code	L	Holes
CSST2408	8mm	6
CSST2410	10mm	6
CSST2412	12mm	6
CSST2414	14mm	6
CSST2416	16mm	6
CSST2418	18mm	6
CSST2420	20mm	6
CSST2422	22mm	6
CSST2424	24mm	3
CSST2426	26mm	3
CSST2428	28mm	3
CSST2430	30mm	3

### Locking Screws Caddy 2.7/3.5mm



Code	Specification	U.P.\$
025.010	235X125X73mm	351.6

#### 2.7mm Locking Self Tapping Screws T8 Torx

Code	L	Holes
LS2710	10mm	8
LS2712	12mm	8
LS2714	14mm	8
LS2716	16mm	8
LS2718	18mm	8
LS2720	20mm	8
LS2722	22mm	8
LS2724	24mm	8
LS2726	26mm	8
LS2728	28mm	4
LS2730	30mm	4
LS2732	32mm	4
LS2734	34mm	4

#### 2.7mm Cortex Self Tapping Screws 2.5mm hexagonal

Code	L	Holes
CSST2710	10mm	6
CSST2712	12mm	6
CSST2714	14mm	6
CSST2716	16mm	6
CSST2718	18mm	6
CSST2720	20mm	6
CSST2722	22mm	6
CSST2724	24mm	6
CSST2726	26mm	6
CSST2728	28mm	3
CSST2730	30mm	3
CSST2732	32mm	3
CSST2734	34mm	3

#### 3.5mm Locking Self Tapping Screws T15 Torx

Code	L	Holes
LS3510	10mm	8
LS3512	12mm	8
LS3514	14mm	8
LS3516	16mm	8
LS3518	18mm	8
LS3520	20mm	8
LS3522	22mm	8
LS3524	24mm	8
LS3526	26mm	8
LS3528	28mm	8
LS3530	30mm	8
LS3532	32mm	8
LS3534	34mm	8
LS3536	36mm	8
LS3538	38mm	8
LS3540	40mm	8
LS3545	45mm	4
LS3550	50mm	4
LS3555	55mm	4
LS3560	60mm	4

#### 3.5mm Cortex Self Tapping Screws 2.5mm hexagonal

Code	L	Holes
CSST3512	12mm	6
CSST3514	14mm	6
CSST3516	16mm	6
CSST3518	18mm	6
CSST3520	20mm	6
CSST3522	22mm	6
CSST3524	24mm	6
CSST3526	26mm	6
CSST3528	28mm	6
CSST3530	30mm	6
CSST3532	32mm	6
CSST3534	34mm	6
CSST3536	36mm	6
CSST3538	38mm	6
CSST3540	40mm	6
CSST3545	45mm	3
CSST3550	50mm	3
CSST3555	55mm	3
CSST3560	60mm	3

### 5.5mm Cortex Self Tapping Screws Set

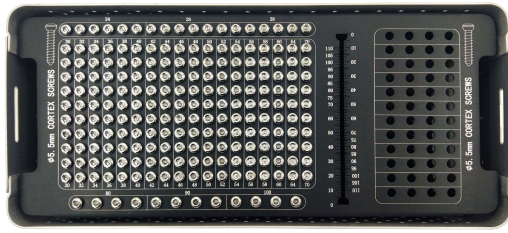

Code	Specification	U.P.\$
000017	360X160X110mm	432.3

5.5mm Cortex Self Tapping Screws 3.5mm hexagonal		
Code	L	Holes
CSST5524	24mm	6
CSST5526	26mm	6
CSST5528	28mm	6
CSST5530	30mm	10
CSST5532	32mm	10
CSST5534	34mm	10
CSST5536	36mm	10
CSST5538	38mm	10

5.5mm Cortex Self Tapping Screws 3.5mm hexagonal		
Code	L	Holes
CSST5540	40mm	10
CSST5542	42mm	10
CSST5544	44mm	10
CSST5546	46mm	10
CSST5548	48mm	10
CSST5550	50mm	10
CSST5552	52mm	10
CSST5554	54mm	10

5.5mm Cortex Self Tapping Screws 3.5mm hexagonal		
Code	L	Holes
CSST5556	56mm	10
CSST5558	58mm	10
CSST5560	60mm	10
CSST5564	64mm	10
CSST5570	70mm	10
CSST5580	80mm	4
CSST5590	90mm	4
CSST55100	100mm	4

### 5.0mm Locking Screws Set

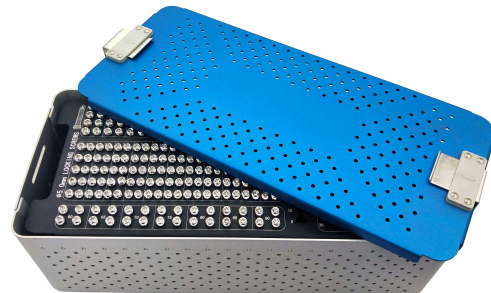
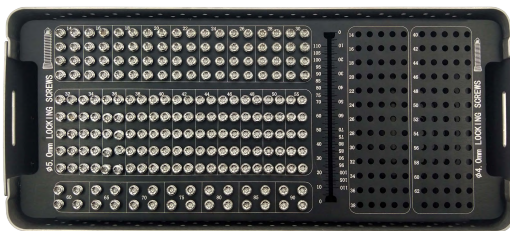

Code	Specification	U.P.\$
000018	360X160X110mm	464.5

5.0mm Locking Self Tapping Screws T25 Torx		
Code	L	Holes
LS5014	14mm	8
LS5016	16mm	8
LS5018	18mm	8
LS5020	20mm	8
LS5022	22mm	8
LS5024	24mm	8
LS5026	26mm	8
LS5028	28mm	10
LS5030	30mm	8

5.0mm Locking Self Tapping Screws T25 Torx		
Code	L	Holes
LS5032	32mm	10
LS5034	34mm	10
LS5036	36mm	10
LS5038	38mm	10
LS5040	40mm	10
LS5042	42mm	10
LS5044	44mm	10
LS5046	46mm	10
LS5048	48mm	10

5.0mm Locking Self Tapping Screws T25 Torx		
Code	L	Holes
LS5050	50mm	10
LS5055	55mm	10
LS5060	60mm	4
LS5065	64mm	4
LS5070	70mm	4
LS5075	75mm	4
LS5080	80mm	4
LS5085	85mm	4
LS5090	90mm	4

# Stainless Cuttable Plates

## 1.5mm Cuttable Plates

Veterinary Use Only Stainless Steel 316LVM

Unit mm

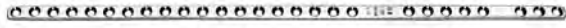

3+5Holes With Space

4+5Holes With Space

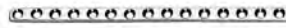

Code	Width	Thickness	Holes Distance	Holes	L	U.P.\$
CP153827	3.8	1.3	5	27	150	74.2

Matching Screws ● CSST15/CSTT15

## 1.5mm Double T Head Cuttable Malleable

Veterinary Use Only Stainless Steel 316LVM

Unit mm



Code	Width	Thickness	Holes Distance	Holes	L	U.P.\$
MPT153830	3.8	1.3	5	30	160	122.6

Matching Screws ● CSST15/CSTT15

## 2.0mm Cuttable Plates

Veterinary Use Only Stainless Steel 316LVM

Unit mm

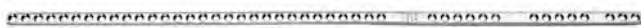

3+5Holes With Space

6+5Holes With Space

4+6Holes With Space

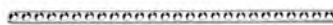

Code	Width	Thickness	Holes Distance	Holes	L	U.P.\$
CP205044	5	1.5	5	44	250	125.8

Matching Screws ● CSST20/CSTT20, CSST15/CSTT15

## 2.4mm Cuttable Plates

Veterinary Use Only Stainless Steel 316LVM

Unit mm



3+5Holes With Space

6+5Holes With Space

2+6Holes With Space



Code	Width	Thickness	Holes Distance	Holes	L	U.P.\$
CP246523	6.5	1.8	6	23	161	77.4

Matching Screws ● CSST24/CSTT24



# Stainless Cuttable Malleable Plates

## 1.5mm Cuttable Malleable Plates

Veterinary Use Only

Stainless Steel 316LVM

Unit mm



Code	Width	Thickness	Holes Distance	Holes	L	U.P.\$
CM154020	4	1.3	5	20	100	74.2

Matching Screws ● CSST15/CSTT15

## 2.0mm Cuttable Malleable Plates

Veterinary Use Only

Stainless Steel 316LVM

Unit mm



Code	Width	Thickness	Holes Distance	Holes	L	U.P.\$
CM205020	5	1.5	5	20	100	67.7

Matching Screws ● CSST20/CSTT20, CSST15/CSTT15

## 2.0mm High Strength Double Compression Plate

Veterinary Use Only

Stainless Steel 316LVM

Unit mm



Code	Width	Thickness	Holes	L	U.P.\$
DCP20180	5.5	1.7	28	180	125.8

Matching Screws ● CSST20/CSTT20, CSST15/CSTT15

## 2.4mm Cuttable Malleable Plates

Veterinary Use Only

Stainless Steel 316LVM

Unit mm



Code	Width	Thickness	Holes Distance	Holes	L	U.P.\$
CM246525	6.5	2.0	6.5	25	161	80.6

Matching Screws ● CSST24/CSTT24

# Stainless Cuttable Malleable Plates

2.4mm High Strength Double Compression Plate **Veterinary Use Only** Stainless Steel 316LVM

Unit mm

Code	Width	Thickness	Holes Distance	Holes	L	U.P.\$
DCP24180	7	2.3	6	23	180	122.6



Matching Screws ● CSST24/CSTT24

2.7mm Cuttable Malleable Plates **Veterinary Use Only** Stainless Steel 316LVM

Unit mm

Code	Width	Thickness	Holes Distance	Holes	L	U.P.\$
CM272020	8	2.2	8	20	160	77.4



Matching Screws ● CSST24/CSTT24, CSST27/CSTT27

2.7mm High Strength Double Compression Plate **Veterinary Use Only** Stainless Steel 316LVM

Unit mm

Code	Width	Thickness	Holes Distance	Holes	L	U.P.\$
DCP27180	8.5	3	8	23	180	112.9



Matching Screws ● CSST27/CSTT27

3.5mm Compression Cuttable Malleable **Veterinary Use Only** Stainless Steel 316LVM

Unit mm

Code	Width	Holes	L	U.P.\$
RC3522	11	22	260	125.8



Matching Screws ● CSST35/CSTT35

# Stainless Steel Round Hole Plates

1.5mm Circular Hole Straight Plates(Width 4mm) **Veterinary Use Only** Stainless Steel 316LVM



Unit mm

Code	Holes	Thickness	L	U.P.\$
P1508	8	1.5	42	29
P1509	9	1.5	47	32.3
P1510	10	1.5	52	35.5
P1511	11	1.5	57	38.7
P1512	12	1.5	62	41.9

Matching Screws ● CSST15/CSTT15

2.0mm Round Hole Plates Straight Plates(Width 5mm) **Veterinary Use Only** Stainless Steel 316LVM



Unit mm

Code	Holes	Thickness	L	U.P.\$
P200428	4	1.5	28	24.2
P200640	6	1.5	40	27.4
P200852	8	1.5	52	30.6
P201064	10	1.5	64	35.5

Matching Screws ● CSST20/CSTT20, CSST15/CSTT15

3.5mm One-Third Tubular Plates Steel Plates **Veterinary Use Only** Stainless Steel 316LVM



Unit mm

Code	Holes	Thickness	L	U.P.\$
QP35.06	6	1.5	64	29
QP35.07	7	1.5	86	32.3
QP35.08	8	1.5	98	35.5
QP35.09	9	1.5	110	38.7
QP35.16	16	1.5	194	48.4

Matching Screws ● CSST35/CSTT35

'L' Plates Round Hole **Veterinary Use Only** Stainless Steel 316LVM



Unit mm

Code	Specification	Thickness	Holes	U.P.\$
LP2006TR	90° Right	2.0mm	2+4	30.6
LP2006TL	90° Left	2.0mm	2+4	30.6
LP2006OR	130° Right	2.0mm	2+4	30.6
LP2006OL	130° Left	2.0mm	2+4	30.6

Matching Screws ● CSST20/CSTT20, CSST15/CSTT15

Neutral/Lengthening Plates

Veterinary Use Only

Stainless Steel 316LVM

Unit mm



Code	Width	Thickness	Holes	L	U.P.\$
LP200650	5.0	1.5	6	20/50	32.3
LP200760	5.0	1.5	7	25/60	35.5
LP200870	5.0	1.5	8	30/70	38.7
LP240652	6.5	2.0	6	52	38.7
LP240659	6.5	2.0	6	59	38.7
LP240865	6.5	2.0	8	65	41.9
LP240872	6.5	2.0	8	72	41.9
LP270665	8.0	2.5	6	65	41.9
LP270897	8.0	2.5	8	97	45.2



'T' Plates

Veterinary Use Only

Stainless Steel 316LVM

Unit mm



Code	Specification	Head Wide	Shaft Width	Thickness	Holes	L	U.P.\$
TP150304	1.5	8.0	3.8	1.5	Head 3/Shaft 4	29	45.2
TP150205	1.5	8.0	3.8	1.5	Head 2/Shaft 5	32	45.2
TP200204	2.0	12	5.2	1.5	Head 2/Shaft 4	37	29
TP200203C	Compression2.0	8.8	5.2	1.5	Head 2/Shaft 4	28	41.9
TP200205C	Compression2.0	8.8	5.2	1.5	Head 2/Shaft 5	42	45.2
TP200203C	Compression2.0	8.8	5.2	1.5	Head 3/Shaft 3	35	48.4
TP200304C	Compression2.0	8.8	5.2	1.5	Head 3/Shaft 4	49	51.6
TP200308C	Compression2.0	8.8	5.2	1.5	Head 3/Shaft 8	70	67.7
TP240307	2.4	11.5	6.5	2.0	Head 3/Shaft 7	63	45.2
TP240208	2.4	14	6.5	2.0	Head 2/Shaft 8	60	35.5
TP270208	2.7	15	8.0	2.5	Head 2/Shaft 8	72	35.5
TP350208	3.5	21	11	3.5	Head 2/Shaft 8	97	41.9

# Acetabular Plates

## Acetabular Plates

Veterinary Use Only Stainless Steel 316LVM

Unit mm



Code	Use Screw	Holes	U.P.\$
AP1504	1.5	4	74.2
AP2004	2.0	4	74.2
AP2406	2.4	6	74.2
AP2706	2.7	6	58.1
AP3506	3.5	6	58.1

## Butterfly Plate

Veterinary Use Only Stainless Steel 316LVM

Unit mm

1.5mm 1.0mm Plate Thickness

2.0mm 1.5mm Plate Thickness



BTFP15414



BTFP20416



BTFP15415



BTFP20417



BTFP15619



BTFP20623

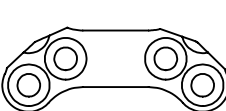
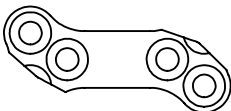
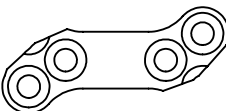
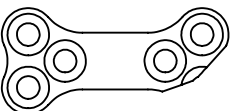
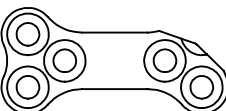
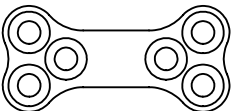

Code	Thickness	Holes	L	U.P.\$
BTFP15414	1.5	4	14	45.2
BTFP15415	1.5	4	15	45.2
BTFP15619	1.5	6	19	58.1
BTFP20416	2.0	4	16	45.2
BTFP20417	2.0	4	17	45.2
BTFP20623	2.0	6	23	58.1
BTFP24418	2.4	4	18	45.2
BTFP24420	2.4	4	20	45.2
BTFP24626	2.4	6	26	61.3
BTFP27421	2.7	4	21	45.2
BTFP27425	2.7	4	25	45.2
BTFP27630	2.7	6	30	61.3

Supracondylar Plates

Veterinary Use Only Stainless Steel 316LVM

Unit mm

Code	Specification	Shaft Width	Holes	L	U.P.\$
SP2016L	2.0 Left	5.5	16	75	106.5
SP2016R	2.0 Right	5.5	16	75	106.5
SP2410L	2.4 Left	6.5	10	75	106.5
SP2410R	2.4 Right	6.5	10	75	106.5
SP2710L	2.7 Left	8	10	75	106.5
SP2710R	2.7 Right	8	10	75	106.5
SP3513L	3.5 Left	11	13	132	106.5
SP3513R	3.5 Right	11	13	132	106.5

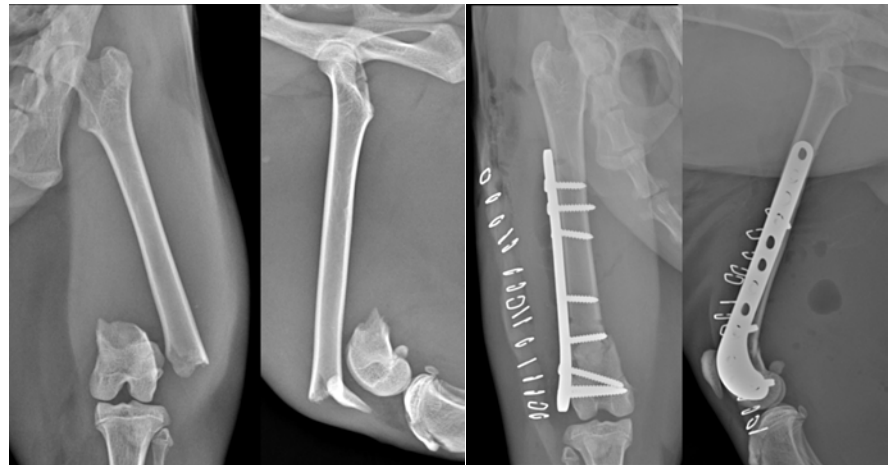

Supracondylar Osteotomy Plates(SCOP)

Veterinary Use Only Stainless Steel 316LVM

Unit mm

Code	Specification	Left/Right	L	U.P.\$
SP2708R	2.7	Right	75	125.8
SP2708L	2.7	Left	75	125.8



Partial Carpal Athrodesis Plate

Veterinary Use Only Stainless Steel 316LVM

Unit mm

Code	Specification	Head Width	Shaft Width	U.P.\$
PCA1520	1.5/2.0	8	5	77.4



## Forelimb Salvage Plate

Veterinary Use Only Stainless Steel 316LVM

Unit mm



Code	Specification	L X Width	U.P.\$
FS1520	1.5/2.0	80X4/6mm	142
FS1524	1.5/2.0/2.4	91X3.5/3.5/6.5mm	255

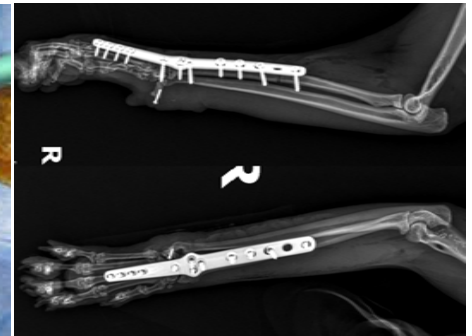

## Pancarpal Arthrodesis Locking Plate

Veterinary Use Only Titanium Grade 5

Unit mm



Code	Specification	L X Width	U.P.\$
FS1115L	1.2/1.5	68X4.5/3.5mm	432



Matching Screws ● LS12/LS15/TCS11

## Pantarsal Arthrodesis Plate

Veterinary Use Only Stainless Steel 316LVM

Unit mm

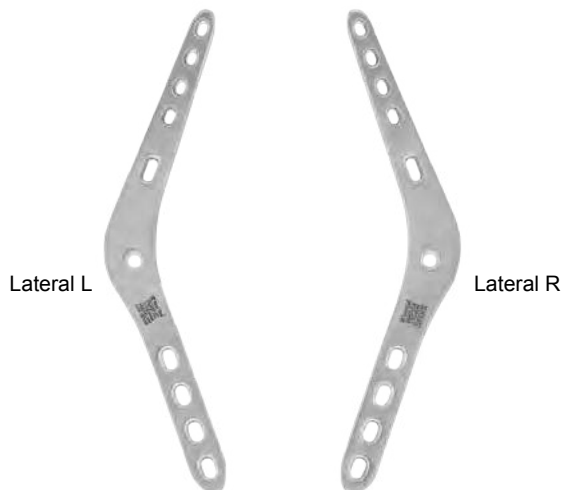

Code	Specification	Left/Right	U.P.\$
PAP1520R	1.5/2.0	Right	206.5
PAP1520L	1.5/2.0	Left	206.5
PAP2024R	2.0/2.4	Right	190.3
PAP2024L	2.0/2.4	Left	190.3
PAP2027R	2.0/2.7	Right	174.2
PAP2027L	2.0/2.7	Left	174.2
PAP2027BR	2.0/2.7	Right	158.1
PAP2027BL	2.0/2.7	Left	158.1
PAP2435R	2.4/3.5	Right	158.1
PAP2435L	2.4/3.5	Left	158.1
PAP2735R	2.7/3.5	Right	141.9
PAP2735L	2.7/3.5	Left	141.9



# Small Animal Bone Plate Set



## Small Animal Bone Plate Set

Code	Products Name/Specification	Quantity
000003B	Small Animal Bone Plate Set	
LP240865	6.5mm Lengthening Plates 8Hole L65mm	1
RC3522	3.5mm Cuttable Malleable Plates 22Hole L260mm	1
CM272020	2.7mm Cuttable Malleable Plates 20Hole L160mm	1
CM205020	2.0mm Cuttable Malleable Plates 20Hole L100mm	1
CP205044	2.0mm Cuttable Plates 44Hole L250mm	1
VP200.08	2.0mm Compression Plates 8Hole L43mm	1
SP2016R	2.0mm Supracondylar Plates Right 16Hole	1
SP2410R	2.4mm Supracondylar Plates Right 10Hole	1
AP2004	2.0mm Acetabular Plates 4Hole	1
AP2706	2.7mm Acetabular Plates 6Hole	1
TP150304	1.5mm 'T' Plates 3*4Hole	1
TP200203C	2.0mm 'T' Plates 2*3Hole	1
TP200304C	2.0mm 'T' Plates 3*4Hole	1
TP270208	2.7mm 'T' Plates 2*8Hole	1
VP270.08	2.7mm Compression Plates 8Hole L69mm	1
LP270897	8mm Lengthening Plates 8Hole L97mm	Optional
LP200870	5.0mm Lengthening Plates 8Hole L30/70mm	Optional
CP246523	2.4mm Cuttable Plates 23Hole L161mm	Optional
VP200.05	2.0mm Compression Plates 5Hole L28mm	Optional
VP200.09	2.0mm Compression Plates 9Hole L48mm	Optional
VP200.12	2.0mm Compression Plates 12Hole L63mm	Optional
SP2710R	2.7mm Supracondylar Plates Right 10Hole	Optional
SP3513R	3.5mm Supracondylar Plates Right 13Hole	Optional
VP270.11	2.7mm Compression Plates 11Hole L93mm	Optional
VP270.04	2.7mm Compression Plates 4Hole L37mm	Optional
VP270.07	2.7mm Compression Plates 7Hole L61mm	Optional
VP270.10	2.7mm Compression Plates 10Hole L85mm	Optional
VP270.12	2.7mm Compression Plates 12Hole L101mm	Optional

Code	Products Name/Specification	Quantity
LP200650	5.0mm Lengthening Plates 6Hole L20/50mm	1
LP200760	5.0mm Lengthening Plates 7Hole L25/60mm	1
CM246525	2.4mm Cuttable Malleable Plates 25Hole L161mm	1
CP153827	1.5mm Cuttable Plates 27Hole L150mm	1
VP200.06	2.0mm Compression Plates 6Hole L33mm	1
SP2016L	2.0mm Supracondylar Plates Left 16Hole	1
SP2410L	2.4mm Supracondylar Plates Left 10Hole	1
AP1504	1.5mm Acetabular Plates 4Hole	1
AP2406	2.4mm Acetabular Plates 6Hole	1
AP3506	3.5mm Acetabular Plates 6Hole	1
TP150205	1.5mm 'T' Plates 2*5Hole	1
TP200205C	2.0mm 'T' Plates 2*5Hole	1
TP240208	2.4mm 'T' Plates 2*8Hole	1
VP270.06	2.7mm Compression Plates 6Hole L53mm	1
LP240659	6.5mm Lengthening Plates 6Hole L59mm	Optional
CM154020	1.5mm Cuttable Malleable Plates 20Hole L100mm	Optional
VP200.04	2.0mm Compression Plates 4Hole L23mm	Optional
VP200.07	2.0mm Compression Plates 7Hole L38mm	Optional
VP200.10	2.0mm Compression Plates 10Hole L53mm	Optional
SP2710L	2.7mm Supracondylar Plates Left 10Hole	Optional
SP3513L	3.5mm Supracondylar Plates Left 13Hole	Optional
VP200.10	2.0mm Compression Plates 10Hole L53mm	Optional
TP350208	3.5mm 'T' Plates 2*8Hole	Optional
VP270.05	2.7mm Compression Plates 5Hole L45mm	Optional
VP270.09	2.7mm Compression Plates 9Hole L77mm	Optional
VP270.11	2.7mm Compression Plates L11Hole	Optional

Standard Set U.P.\$ 1893.8

Full Set U.P.\$ 3336



# Compression Plates DCP

## 2.0mm DCP

Veterinary Use Only Stainless Steel 316LVM



Unit mm

Code	Width	Thickness	Holes	L	U.P.\$
VP200.04	5	1.5	4	23	29
VP200.05	5	1.5	5	28	32.3
VP200.06	5	1.5	6	33	35.5
VP200.07	5	1.5	7	38	38.7
VP200.08	5	1.5	8	43	41.9
VP200.09	5	1.8	9	48	45.2
VP200.10	5	1.8	10	53	48.4
VP200.11	5	1.8	11	58	51.6
VP200.12	5	1.8	12	63	54.8
VP200.14	5	1.8	14	73	61.3

Matching Screws ● CSST20/CSTT20

## 2.7mm DCP

Veterinary Use Only Stainless Steel 316LVM



Unit mm

Code	Width	Thickness	Holes	L	U.P.\$
VP270.04	8	2	4	37	35.5
VP270.05	8	2	5	45	38.7
VP270.06	8	2	6	53	41.9
VP270.07	8	2	7	61	45.2
VP270.08	8	2	8	69	48.4
VP270.09	8	2	9	77	51.6
VP270.10	8	2	10	85	54.8
VP270.11	8	2	11	93	58.1
VP270.12	8	2	12	101	61.3

Matching Screws ● CSST27/CSTT27

## 3.5mm DCP-Narrow

Veterinary Use Only Stainless Steel 316LVM



Unit mm

Code	Width	Thickness	Holes	L	U.P.\$
VP35N.06	10	2.8	6	77	41.9
VP35N.07	10	2.8	7	89	45.2
VP35N.08	10	2.8	8	101	48.4
VP35N.09	10	2.8	9	113	51.6
VP35N.10	10	2.8	10	125	54.8
VP35N.12	10	2.8	12	149	58.1
VP35N.14	10	2.8	14	173	61.3

Matching Screws ● CSST35/CSTT35

## 3.5mm DCP-Broad

Veterinary Use Only Stainless Steel 316LVM



Unit mm

Code	Width	Thickness	Holes	L	U.P.\$
VP35B.08	12	3.3	8	116	48.4
VP35B.10	12	3.3	10	144	54.8
VP35B.12	12	3.3	12	172	58.1
VP35B.14	12	3.3	14	200	61.3

Matching Screws ● CSST35/CSTT35

# Limited Contact Compression Plates LC-DCP

## 2.0mm/1.5mm LC-DCP

Veterinary Use Only Stainless Steel 316LVM



Unit mm

Code	Width	Thickness	Holes Distance	Holes	L	U.P.\$
VP3011.05	5	1.8	6	5	31	56.5
VP3011.06	5	1.8	6	6	37	61.3
VP3011.07	5	1.8	6	7	43	66.1
VP3011.08	5	1.8	6	8	49	71
VP3011.09	5	1.8	6	9	55	75.8
VP3011.10	5	1.8	6	10	61	80.6
VP3011.12	5	1.8	6	12	73	88.7
VP3011.14	5	1.8	6	14	85	96.8

Matching Screws ● CSST15, CSST20/CSTT20

## 2.4mm/2.0mm LC-DCP

Veterinary Use Only Stainless Steel 316LVM



Unit mm

Code	Width	Thickness	Holes Distance	Holes	L	U.P.\$
VP3021.04	6.5	2.5	8	4	41	51.6
VP3021.05	6.5	2.5	8	5	45	56.5
VP3021.06	6.5	2.5	8	6	49	61.3
VP3021.07	6.5	2.5	8	7	57	66.1
VP3021.08	6.5	2.5	8	8	65	71
VP3021.09	6.5	2.5	8	9	73	75.8
VP3021.10	6.5	2.5	8	10	81	80.6
VP3021.12	6.5	2.5	8	12	97	88.7
VP3021.14	6.5	2.5	8	14	113	96.8

Matching Screws ● CSST20/CSTT20, CSST24/CSTT24

## 2.7mm LC-DCP

Veterinary Use Only Stainless Steel 316LVM



Unit mm

Code	Width	Thickness	Holes Distance	Holes	L	U.P.\$
VP3031.04	8	2.5	9	4	46	51.6
VP3031.05	8	2.5	9	5	46	56.5
VP3031.06	8	2.5	9	6	55	61.3
VP3031.07	8	2.5	9	7	64	66.1
VP3031.08	8	2.5	9	8	73	71
VP3032.09	8	3	9	9	82	75.8
VP3032.10	8	3	9	10	91	80.6
VP3032.11	8	3	9	11	100	85.5
VP3032.12	8	3	9	12	109	90.3
VP3032.14	8	3	9	14	127	96.8
VP3032.16	8	3	9	16	145	104.8

Matching Screws ● CSST27/CSTT27

# Limited Contact Compression Plates LC-DCP

## 3.5mm LC-DCP

Veterinary Use Only Stainless Steel 316LVM



Unit mm

Code	Width	Thickness	Holes Distance	Holes	L	U.P.\$
VP3041.06	11	3.2	13	6	80	61.3
VP3041.07	11	3.2	13	7	93	66.1
VP3041.08	11	3.2	13	8	106	71
VP3041.09	11	3.2	13	9	119	75.8
VP3041.10	11	3.2	13	10	132	80.6
VP3041.11	11	3.2	13	11	145	85.5
VP3041.12	11	3.2	13	12	158	90.3
VP3041.14	11	3.2	13	14	184	96.8
VP3041.16	11	3.2	13	16	210	104.8

Matching Screws ● CSST35/CSTT35

## 4.5mm LC-DCP Narrow

Veterinary Use Only Stainless Steel 316LVM



Unit mm

Code	Width	Thickness	Holes Distance	Holes	L	U.P.\$
VP3060.08	13.5	4.2	18	8	142	64.5
VP3060.09	13.5	4.2	18	9	160	72.6
VP3060.10	13.5	4.2	18	10	178	80.6
VP3060.11	13.5	4.2	18	11	196	88.7
VP3060.12	13.5	4.2	18	12	214	96.8
VP3060.14	13.5	4.2	18	14	250	112.9
VP3060.16	13.5	4.2	18	16	286	129
VP3060.18	13.5	4.2	18	18	323	145.2
VP3060.20	13.5	4.2	18	20	358	161.3
VP3060.22	13.5	4.2	18	22	394	177.4

Matching Screws ● CSST45/CSTT45

## 4.5mm LC-DCP Broad

Veterinary Use Only Stainless Steel 316LVM



Unit mm

Code	Width	Thickness	Holes Distance	Holes	L	U.P.\$
VP3070.08	17.5	5.2	18	8	142	80.6
VP3070.09	17.5	5.2	18	9	160	88.7
VP3070.10	17.5	5.2	18	10	178	96.8
VP3070.11	17.5	5.2	18	11	196	104.8
VP3070.12	17.5	5.2	18	12	214	112.9
VP3070.14	17.5	5.2	18	14	250	129
VP3070.16	17.5	5.2	18	16	286	145.2
VP3070.18	17.5	5.2	18	18	322	161.3
VP3070.20	17.5	5.2	18	20	358	177.4
VP3070.22	17.5	5.2	18	22	394	193.5

Matching Screws ● CSST45/CSTT45

# LC-DCP Instruments Set



## LC-DCP Instruments Set 1.5/2.0/2.4/2.7/3.5mm

Code	Products Name/Specification	Quantity
100000	Medium Fragment Forceps-Pointed 160mm	1
100001	Small Fragment Forceps-Pointed 135mm	1
100016	Mini Serrated Bone Holding Forceps 5mm	1
100017	Mini Serrated Bone Holding Forceps 3mm	1
100019	Self Centering Forceps Very Small	1
100012	Reduction Forceps Serrated Jaws Spinlock 180mm	1
100020	Self Centering Forceps Small	1
100032	Implant Cutting Forcep	1
100031	End Cutting Forceps	1
100042	Small Jacobs Chuck With Straight Handle 0-4mm	1
100047	Wire Passers Diameter 20mm	1
100051	Cerclage Wire Twisters/Tighteners/Cutter	1
100052	K'Wire/Small PinPunch 1.5-2.5mm	1
100054	K' Wire Bender	1
100083	Ruskin (Liston) Rongeur 2mm	1
100131	Osteophyte Rasp	1
110098	AO Type Periosteal Elevator Curved Edge 8mm	1
100097	Double End Periosteal Elevator 5mm	1
100144	Mini Hohman Retractor 6mm	1
100145	Mini Hohman Retractor 8mm	1
100146	Mini Hohman Retractor 12mm	1
100141b	Hohman Retractor Broad 20mm	1
100149	Gelpi Self Retaining Retractor 140mm	2
110156	Double-head Hooks Sharp Teeth	2
100065	AO type 1.5/2.0/2.4 Bending Levers 1.5/2.0/2.4 pair	1
100066	AO type 2.7/3.5 Bending Levers 2.7/3.5 pair	1

Code	Products Name/Specification	Quantity
100236	Depth gauge 0-30mm	1
100237	Depth gauge 0-50mm	1
100218	1.5 Hex Screwdriver+Sleeve-with Fibre Handle	1
100222	2.5 Hex Screwdriver+Sleeve-with Fibre Handle	1
100159	AO T Tap Handle	1
100240	AO QC Countersink $\Phi$ 4	1
100242	AO QC Countersink $\Phi$ 6	1
100170	AO QC Taps 1.5mm	1
100171	AO QC Taps 2.0mm	1
100172	AO QC Taps 2.4mm	1
100173	AO QC Taps 2.7mm	1
100174	AO QC Taps 3.5mm	1
100178	Combination Drill Tap and Insert Sleeve 1.1/1.5mm	1
100179	Combination Drill Tap and Insert Sleeve 1.5/2.0mm	1
100180	Combination Drill Tap and Insert Sleeve 1.8/2.4mm	1
100181	Combination Drill Tap and Insert Sleeve 2.0/2.7mm	1
100182	Combination Drill Tap and Insert Sleeve 2.5/3.5mm	1
100211	For 2.0mm Compression Plates Load Neutral Drill Guides	1
100212	For 2.4mm Compression Plates Load Neutral Drill Guides	1
100213	For 2.7mm Compression Plates Load Neutral Drill Guides	1
100215	For 3.5mm Compression Plates Load Neutral Drill Guides	1
10031X	Temporary Bending Template	4
A32A11	1.1mm Drill Bit	1
A32A15	1.5mm Drill Bit	1
A32A18	1.8mm Drill Bit	1
A32A20	2.0mm Drill Bit	1
A32A24	2.4mm Drill Bit	1
A32A25	2.5mm Drill Bit	1
A32A27	2.7mm Drill Bit	1
A32A35	3.5mm Drill Bit	1
000006E	Sterilization Case	1
000006	LC-DCP Instruments Set	

U.P.\$	3643.5
--------	--------

# Small Orthopedic AO QC Set



## Small Orthopedic AO QC Set (265x180x55mm)

Code	Products Name/Specification	Quantity
A32QC11~35	Drill Bits , QC 1.1/1.5/1.8/2.0/2.5/2.7/3.5mm	Ea 1
100170~100174	QCCortexTaps1.5/2.0/2.4/2.7/3.5mm	Ea 1
100219	Screwdriver+Sleeve QC Hexagonal 1.5mm	1
100222	Screwdriver+Sleeve QC Hexagonal 2.5mm	1
100240	Countersink $\Phi$ 4.0mm QC	1
100242	Countersink $\Phi$ 6.0mm QC	1
100198	Periosteal Elevator QC 5mm Width	1
100255	Extraction Trepine 1.5mm QC	1
100256	Extraction Trepine 2.5mm QC	1
100246	Extraction Screw Hexagonal 1.8mm QC	1
100247	Extraction Screw Hexagonal 2.5mm QC	1
100248	Extraction Screw Hexagonal 3.0mm QC	1
100160	AO QC Straight Handle with Rotating Cap	1
100159	AO QC T-Tap Handle	1
100178	Combination Drill Tap and Insert Sleeve 1.1/1.5mm	1
100179	Combination Drill Tap and Insert Sleeve 1.5/2.0mm	1
100180	Combination Drill Tap and Insert Sleeve 1.8/2.4mm	1
100181	Combination Drill Tap and Insert Sleeve 2.0/2.7mm	1
100182	Combination Drill Tap and Insert Sleeve 2.5/3.5mm	1
100192	Parallel Drill Guide And Drill Sleeve 2.0mm	1
000003	Small Orthopedic AO QC Set	

U.P.\$ 1372.5

# 1.2/1.5 Micro Locking Plates

## 1.2mm Titanium Double T Locking Plate

Veterinary Use Only

Titanium Grade 5

Unit mm

Code	Width	Thickness	Holes Distance	Holes	L	U.P.\$
VP4002.23	3.5	1	3	23	108	156

Matching Screws ● LS12



## 1.5mm Titanium Double T Locking Plate

Veterinary Use Only

Titanium Grade 5

Unit mm

Code	Width	Thickness	Holes Distance	Holes	L	U.P.\$
VP4001.25	4	1	3	25	154	156

Matching Screws ● LS15



## 1.2mm T Locking Plate

Veterinary Use Only

Titanium Grade 5

Unit mm

Code	Width	Thickness	Holes Distance	Holes	L	U.P.\$
VP4012.5	3.5	1	3	5+2	28	77

Matching Screws ● LS12



### 1.5mm T Locking Plate

Veterinary Use Only Titanium Grade 5



Unit mm

Code	Width	Thickness	Holes Distance	Holes	L	U.P.\$
VP4015.5	4	1	3	5+2	28	77

Matching Screws ● LS15

### 1.2/1.5mm Lengthening Locking Plate

Veterinary Use Only Titanium Grade 5



Unit mm

Code	Width	Thickness	Holes	L	U.P.\$
LLP12423	3.5	1.5	4	23.5	43
LLP12635	3.5	1.5	6	23.5	48
LLP12643	3.5	1.5	6	23.5	52

Matching Screws ● LS12 The Reconstruction Plate End Can Be Side Contoured Inside 15°



Unit mm

Code	Width	Thickness	Holes	L	U.P.\$
LLP15540	4	1.5	5	40	43
LLP15650	4	1.5	6	50	48
LLP15660	4	1.5	6	60	52
LLP15875	4	1.5	6	75	83

Matching Screws ● LS15 The Reconstruction Plate End Can Be Side Contoured Inside 15°

### 1.5mm Distal Femur Locking Plate

Veterinary Use Only Titanium Grade 5



Unit mm

Code	Specification	Holes	Thickness	L	U.P.\$
DFL15L	1.5 Left	6+3	1.5	36	82
DFL15R	1.5 Right	6+3	1.5	36	82

Matching Screws ● LS15

# 1.2/1.5mm Micro Locking Set

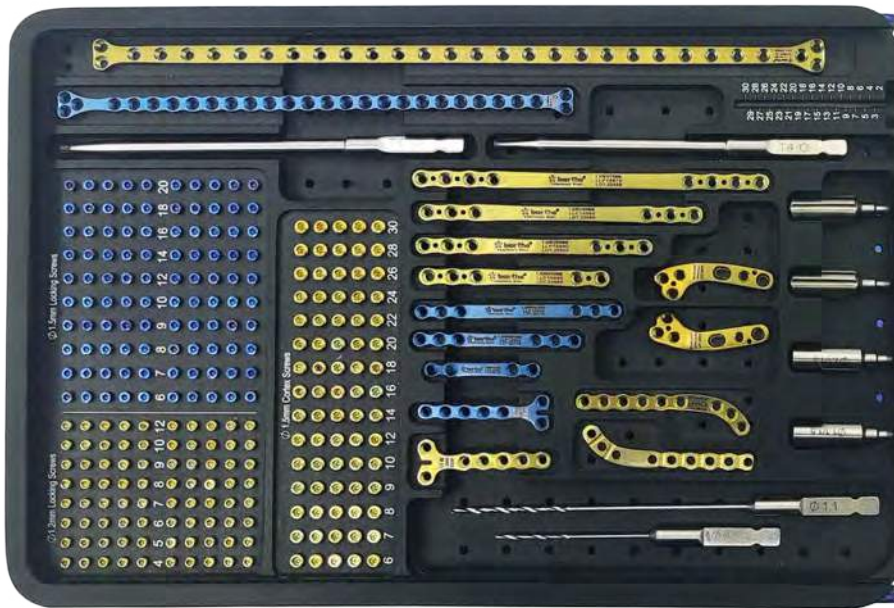

Code	Products Name	Specification	U.P.\$
LCP1215	1.2/1.5 Locking Implants Caddy	185X125X40mm	422

## 1.2/1.5mm Micro Locking Set

Code	Products Name/Specification	Quantity
A32QC11	1.1mm AO Style Quick Coupling Drill Bits	1
A32QC08	0.8mm AO Style Quick Coupling Drill Bits	1
110232	T4 Torx Drive Screwdriver shaft	1
100232	T6 Torx Drive Screwdriver shaft	1
VP4410.L3	1.5mm TPLO Locking Plate,Left	1
VP4410.R3	1.5mm TPLO Locking Plate,Right	1
110189	Locking Threaded Drill Guide 0.8/1.2	1
110188	Locking Threaded Drill Guide 1.1/1.5	1
LCP1215	1.2/1.5 mm Locking Implants Caddy	1
LLP155540	1.5mm Legthening Locking Plate, 5 Holes	1
LLP15650	1.5mm Legthening Locking Plate, 6 Holes	1
LLP15660	1.5mm Legthening Locking Plate, 6 Holes	1
LLP15875	1.5mm Legthening Locking Plate, 8 Holes	1
VP4001.25	1.5mm Double T Cuttable Locking Plate	1
VP4015.5	1.5mm T Locking Plate	1
DFL15L	1.5mm Distal Femur Locking Plate,Left	1
DFL15R	1.5mm Distal Femur Locking Plate,Right	1
LLP12423	1.2mm Legthening Locking Plate,4 Holes	1
LLP12635	1.2mm Legthening Locking Plate,5 Holes	1
LLP12643	1.2mm Legthening Locking Plate,6 Holes	1
VP4012.5	1.2mm T Locking Plate	1
TCS1506	1.5mm Cortex Self Tapping Screws,T6Torx,L 6mm	5
TCS1507	1.5mm Cortex Self Tapping Screws,T6Torx,L 7mm	5
TCS1508	1.5mm Cortex Self Tapping Screws,T6Torx,L 8mm	5
TCS1509	1.5mm Cortex Self Tapping Screws,T6Torx,L 9mm	5
TCS1510	1.5mm Cortex Self Tapping Screws,T6Torx,L 10mm	5

Code	Products Name/Specification	Quantity
TCS1512	1.5mm Cortex Self Tapping Screws,T6Torx,L 12mm	5
TCS1514	1.5mm Cortex Self Tapping Screws,T6Torx,L 14mm	5
TCS1516	1.5mm Cortex Self Tapping Screws,T6Torx,L 16mm	5
TCS1518	1.5mm Cortex Self Tapping Screws,T6Torx,L 18mm	5
TCS1520	1.5mm Cortex Self Tapping Screws,T6Torx,L 20mm	5
TCS1522	1.5mm Cortex Self Tapping Screws,T6Torx,L 22mm	5
TCS1524	1.5mm Cortex Self Tapping Screws,T6Torx,L 24mm	5
TCS1526	1.5mm Cortex Self Tapping Screws,T6Torx,L 26mm	5
TCS1528	1.5mm Cortex Self Tapping Screws,T6Torx,L 28mm	5
TCS1530	1.5mm Cortex Self Tapping Screws,T6Torx,L 30mm	5
LS1204	1.2mm Locking Self Tapping Screws, T4 Torx,L 4mm	10
LS1205	1.2mm Locking Self Tapping Screws,T4 Torx,L 5mm	10
LS1206	1.2mm Locking Self Tapping Screws,T4 Torx,L 6mm	10
LS1207	1.2mm Locking Self Tapping Screws,T4 Torx,L 7mm	10
LS1208	1.2mm Locking Self Tapping Screws,T4 Torx,L 8mm	10
LS1209	1.2mm Locking Self Tapping Screws,T4 Torx,L 9mm	10
LS1210	1.2mm Locking Self Tapping Screws,T4 Torx,L 10mm	10
LS1212	1.2mm Locking Self Tapping Screws,T4 Torx,L 12mm	10
LS1506	1.5mm Locking Self Tapping Screws, T4 Torx,L 6mm	10
LS1507	1.5mm Locking Self Tapping Screws,T4 Torx,L 7mm	10
LS1508	1.5mm Locking Self Tapping Screws,T4 Torx,L 8mm	10
LS1509	1.5mm Locking Self Tapping Screws,T4 Torx,L 9mm	10
LS1510	1.5mm Locking Self Tapping Screws,T4 Torx,L 10mm	10
LS1512	1.5mm Locking Self Tapping Screws,T4 Torx,L 12mm	10
LS1514	1.5mm Locking Self Tapping Screws,T4 Torx,L 14mm	10
LS1516	1.5mm Locking Self Tapping Screws,T4 Torx,L 16mm	10
LS1518	1.5mm Locking Self Tapping Screws,T4 Torx,L 18mm	10
LS1520	1.5mm Locking Self Tapping Screws,T4 Torx,L 20mm	10

U.P.\$	4842
--------	------



## Double T Cuttable Locking Plates

Veterinary Use Only

Stainless Steel 316LVM

Unit mm

Code	Width	Thickness	Holes Distance	Holes	L	U.P.\$
DTL2049	5.0	1.5	5	49	273	292
DTL2434	6.5	2.0	6.5	34	235	208

Matching Screws ● LS20/LS24

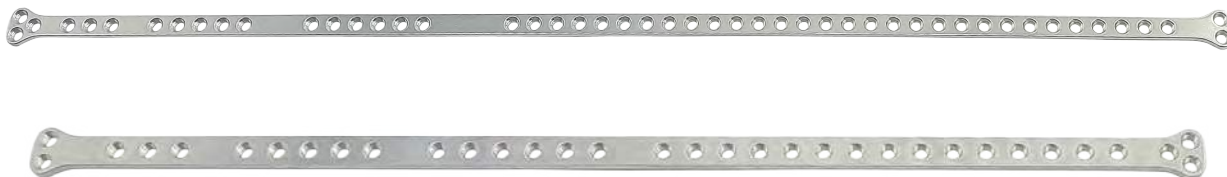

## Cuttable Malleable Locking Plates

Veterinary Use Only

Stainless Steel 316LVM

Unit mm

Code	Width	Thickness	Holes Distance	Holes	L	U.P.\$
LCM205020	5.0	1.5	5	20	100	113
LCM246525	6.5	2.0	6	25	161	121

Matching Screws ● LS20/LS24



## Acetabular Plates

Veterinary Use Only

Stainless Steel 316LVM

Unit mm

Code	Use Screw	Holes	U.P.\$
AP2004L	2.0	4	74
AP2406L	2.4	6	74
AP2706L	2.7	6	58

Matching Screws ● LS20/LS24/LS27



# Locking Compression Plates LCP

## 2.0mm LCP

Veterinary Use Only Stainless Steel 316LVM



Unit mm

Code	Width	Thickness	HD	CHD	Holes	L	U.P.\$
VP4012.06	5	1.5	7	5	6	41	109.7
VP4012.07	5	1.5	7	5	7	48	119.4
VP4012.08	5	1.5	7	5	8	55	129
VP4012.09	5	1.8	7	5	9	62	138.7
VP4012.10	5	1.8	7	5	10	69	148.4
VP4012.12	5	1.8	7	5	12	83	164.5
VP4012.14	5	1.8	7	5	14	97	180.6

Matching Screws ● LS20, CSST15, CSST20/CSTT20

## 2.4mm LCP

Veterinary Use Only Stainless Steel 316LVM



Unit mm

Code	Width	Thickness	HD	CHD	Holes	L	U.P.\$
VP4021.06	6.5	2.2	8	6	6	48	109.7
VP4021.07	6.5	2.2	8	6	7	56	119.4
VP4021.08	6.5	2.2	8	6	8	64	129
VP4022.09	6.5	2.5	8	6	9	72	138.7
VP4022.10	6.5	2.5	8	6	10	80	148.4
VP4022.12	6.5	2.5	8	6	12	96	164.5
VP4022.14	6.5	2.5	8	6	14	112	180.6

Matching Screws ● LS24, CSST20/CSTT20, CSST24/CSTT24

## 2.7mm LCP

Veterinary Use Only Stainless Steel 316LVM



Code	Width	Thickness	HD	CHD	Holes	L	U.P.\$
VP4031.06	8	2.5	9	6	6	54	109.7
VP4031.07	8	2.5	9	6	7	63	119.4
VP4031.08	8	2.5	9	6	8	72	129
VP4031.09	8	2.5	9	6	9	81	138.7
VP4031.10	8	2.5	9	6	10	90	148.4
VP4031.12	8	2.5	9	6	12	108	164.5
VP4031.14	8	2.5	9	6	14	126	180.6
VP4031.16	8	2.5	9	6	16	144	196.8

Matching Screws ● LS27, CSST27/CSTT27

# Locking Compression Plates LCP

## 3.5mm LCP Narrow

Veterinary Use Only Stainless Steel 316LVM



Unit mm

Code	Width	Thickness	HD	CHD	Holes	L	U.P.\$
VP4041.06	11	3.2	13	9.5	6	79	109.7
VP4041.07	11	3.2	13	9.5	7	92	119.4
VP4041.08	11	3.2	13	9.5	8	105	129
VP4041.09	11	3.2	13	9.5	9	118	138.7
VP4041.10	11	3.2	13	9.5	10	131	148.4
VP4041.11	11	3.2	13	9.5	11	144	158.1
VP4041.12	11	3.2	13	9.5	12	157	167.7
VP4041.14	11	3.2	13	9.5	14	183	183.9
VP4041.16	11	3.2	13	9.5	16	209	200

Matching Screws ● LS35, CSST35/CSTT35, CAN40

## 3.5mm LCP Broad

Veterinary Use Only Stainless Steel 316LVM



Unit mm

Code	Width	Thickness	HD	CHD	Holes	L	U.P.\$
VP4045.08	13.5	4	13	9.5	8	107	135.5
VP4045.09	13.5	4	13	9.5	9	120	145.2
VP4045.10	13.5	4	13	9.5	10	133	154.8
VP4045.11	13.5	4	13	9.5	11	146	164.5
VP4045.12	13.5	4	13	9.5	12	159	174.2
VP4045.13	13.5	4	13	9.5	13	172	183.9
VP4045.14	13.5	4	13	9.5	14	185	193.5
VP4045.16	13.5	4	13	9.5	16	211	209.7
VP4045.18	13.5	4	13	9.5	18	237	225.8

Matching Screws ● LS35, CSST35/CSTT35, CAN4.0

## 4.5mm LCP Narrow

Veterinary Use Only Stainless Steel 316LVM



Unit mm

Code	Width	Thickness	HD	CHD	Holes	L	U.P.\$
VP4051.03	13.5	4.2	18	12.8	3	66	125.8
VP4051.06	13.5	4.2	18	12.8	6	107	125.8
VP4051.07	13.5	4.2	18	12.8	7	125	135.5
VP4051.08	13.5	4.2	18	12.8	8	143	145.2
VP4051.09	13.5	4.2	18	12.8	9	161	154.8
VP4051.10	13.5	4.2	18	12.8	10	179	164.5
VP4051.11	13.5	4.2	18	12.8	11	197	174.2
VP4051.12	13.5	4.2	18	12.8	12	215	183.9
VP4051.14	13.5	4.2	18	12.8	14	251	200
VP4051.16	13.5	4.2	18	12.8	16	287	216.1

Matching Screws ● LS50, CSST45/CSTT45, CAN6.5

4.5mm LCP Broad

Veterinary Use Only Stainless Steel 316LVM



Unit mm

Code	Width	Thickness	HD	CHD	Holes	L	U.P.\$
VP4061.08	17.5	5.2	18	12.8	8	143	161.3
VP4061.09	17.5	5.2	18	12.8	9	161	174.2
VP4061.10	17.5	5.2	18	12.8	10	179	187.1
VP4061.11	17.5	5.2	18	12.8	11	197	200
VP4061.12	17.5	5.2	18	12.8	12	215	209.7
VP4061.14	17.5	5.2	18	12.8	14	251	233.9
VP4061.16	17.5	5.2	18	12.8	16	287	258.1
VP4061.18	17.5	5.2	18	12.8	18	323	282.3

Matching Screws ● LS50, CSST45/CSTT4.5, CAN65

5.5mm LCP Broad

Veterinary Use Only Stainless Steel 316LVM



Unit mm

Code	Width	Thickness	HD	CHD	Holes	L	U.P.\$
VP4071.10	17.5	6	18	12.8	10	180	177.4
VP4071.11	17.5	6	18	12.8	11	198	193.5
VP4071.12	17.5	6	18	12.8	12	216	209.7
VP4071.13	17.5	6	18	12.8	13	234	225.8
VP4071.14	17.5	6	18	12.8	14	252	241.9
VP4071.15	17.5	6	18	12.8	15	270	258.1
VP4071.16	17.5	6	18	12.8	16	288	274.2
VP4071.17	17.5	6	18	12.8	17	306	290.3
VP4071.18	17.5	6	18	12.8	18	324	306.5

Matching Screws ● LS50, CSST45/CSTT45, CSST55/CSTT55, CAN65

Pancarpal Arthrodesis Locking Plate

Veterinary Use Only Stainless Steel 316LVM



Unit mm

Code	Specification	Holes	L	U.P.\$
VP4301.11	2.0/2.4mm	10	88	300
VP4301.13	2.0/2.7mm	12	110	300
VP4301.12	2.7/3.5mm	12	151	300

Matching Screws ● VP4301.11 Use LS20/LS24, CSTT20/CSTT24

Matching Screws ● VP4301.13 Use LS20/LS27, CSTT20/CSTT27

Matching Screws ● VP4301.12 Use LS27/LS35, CSTT27/CSTT35



Lengthening Locking Plates

Veterinary Use Only Stainless Steel 316LVM

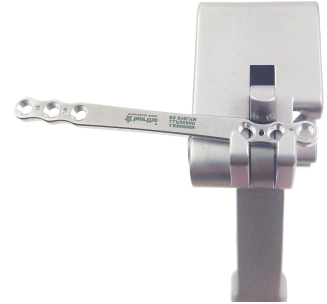
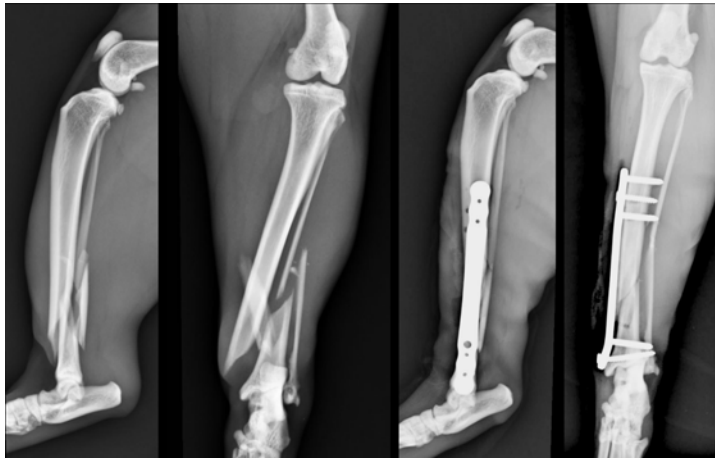

Unit mm

Code	Width	Thickness	Holes	L	U.P.\$
LLP20890	5	2	8	90	116.1
LLP20670	5	2	6	70	96.8
LLP20660	5	2	6	60	87.1
LLP20650	5	2	6	50	77.4
LLP20540	5	2	5	40	67.7

Matching Screws ● LS20 The Reconstruction Plate End Can Be Side Contoured Inside 15°

Unit mm

Code	Width	Thickness	Holes	L	U.P.\$
LLP248120	6	2.5	8	120	106.8
LLP247100	6	2.5	7	100	96.8
LLP24685	6	2.5	6	85	87.1
LLP24670	6	2.5	6	70	77.4
LLP24555	6	2.5	5	55	67.7

Matching Screws ● LS24 The Reconstruction Plate End Can Be Side Contoured Inside 15°

Unit mm

Code	Width	Thickness	Holes	L	U.P.\$
LLP277120	7.5	3	7	120	103.2
LLP276100	7.5	3	6	100	93.5
LLP27680	7.5	3	6	80	83.9
LLP27565	7.5	3	5	65	74.2

Matching Screws ● LS27 The Reconstruction Plate End Can Be Side Contoured Inside 15°

Unit mm

Code	Width	Thickness	Holes	L	U.P.\$
LLP307140	9	3.5	7	140	103.2
LLP306120	9	3.5	6	120	93.5
LLP306100	9	3.5	6	100	83.9
LLP30580	9	3.5	5	80	74.2

Matching Screws ● LS30 The Reconstruction Plate End Can Be Side Contoured Inside 15°

Unit mm

Code	Width	Thickness	Holes	L	U.P.\$
LLP358160	11	4	8	160	119.4
LLP357140	11	4	7	140	109.7
LLP356120	11	4	6	125	100
LLP356105	11	4	6	105	90.3
LLP35590	11	4	5	90	80.6

Matching Screws ● LS35 The Reconstruction Plate End Can Be Side Contoured Inside 15°

## DFO Distal Femur Locking Plate

Veterinary Use Only **Stainless Steel 316LVM**

Unit mm



Code	Width	Thickness	Holes	L	U.P.\$
VP4408.L3	9	3.2	7	89	169
VP4408.R3	9	3.2	7	89	169
VP4409.L3	9	3.2	8	101	169
VP4409.R3	9	3.2	8	101	169

Matching Screws ● LS35 CSTT35



- Anatomic contour matches the surface of the femur.
- Distal locking screw trajectories targeted to avoid the intercondylar notch and stifle joint.
- Tapered design minimizes soft tissue interference.
- Proximal end with reconstruction design for easier contouring

## 3.5mm DPO/TPO Locking Plates

Veterinary Use Only **Stainless Steel 316LVM**



Code	Specification	U.P.\$
VP4601.L7	20° Left	316.1
VP4601.R7	20° Right	316.1
VP4602.L7	25° Left	316.1
VP4602.R7	25° Right	316.1
VP4603.L7	30° Left	316.1
VP4603.R7	30° Right	316.1

Matching Screws ● LS35, CSST35/CSTT35



# LCP Locking Instrument

## Drill Bits

Veterinary Use Only

Unit mm



Code	Products Name	Specification	L	U.P.\$
A32A11	Drill Bits	1.1mm	60mm	3.2
A32A15	Drill Bits	1.5mm	85mm	3.2
A32A18	Drill Bits	1.8mm	100mm	3.2
A32A20	Drill Bits	2.0mm	100mm	3.2
A32A25	Drill Bits	2.5mm	115mm	3.2
A32A28	Drill Bits	2.8mm	165mm	6.5
A32A32	Drill Bits	3.2mm	150mm	4.8
A32A43	Drill Bits	4.3mm	280mm	12.9

● Screws,Taps,Drill Bits Reference Chart On Page 52

## Drill Bits-AO Quick Coupling

Veterinary Use Only

Unit mm



Code	Products Name	Specification	L	U.P.\$
A32QC11	AO Quick Fit Drill Bits	1.1mm	60mm	25.8
A32QC15	AO Quick Fit Drill Bits	1.5mm	85mm	24.2
A32QC18	AO Quick Fit Drill Bits	1.8mm	100mm	24.2
A32QC20	AO Quick Fit Drill Bits	2.0mm	125mm	24.2
A32QC25	AO Quick Fit Drill Bits	2.5mm	150mm	29
A32QC28	AO Quick Fit Drill Bits	2.8mm	165mm	24.2
A32QC32	AO Quick Fit Drill Bits	3.2mm	150mm	29
A32QC43	AO Quick Fit Drill Bits	4.3mm	280mm	32.3

● Screws,Taps,Drill Bits Reference Chart On Page 52

## Star Drive Insert AO QC

Veterinary Use Only

Unit mm



Code	Products Name	Specification	Use Screw	U.P.\$
110232	Star Drive Insert AO QC	T4	1.5mm Locking Screws	45.2
100232	Star Drive Insert AO QC	T6	2.0mm Locking Screws	45.2
100231	Star Drive Insert AO QC	T8	2.4/2.7mm Locking Screws	45.2
100230	Star Drive Insert AO QC	T15	3.5mm Locking Screws	45.2
110230	Star Drive Insert AO QC	T25	5.0mm Locking Screws	45.2

## Hex Screwdriver AO QC

Veterinary Use Only

Unit mm



Code	Products Name	Specification	Use Screw	U.P.\$
100226	Hex Screwdriver AOQC	1.5mm	1.5/2.0/2.4mm Cortex Screws	29
100228	Hex Screwdriver AOQC	2.5mm	2.7/3.0/3.5/4.0mm Cortex Screws	29
100229	Hex Screwdriver AOQC	3.5mm	4.0/5.5mm Cortex Screws	29

## Ratcheting Screwdriver Handle

Veterinary Use Only



Code	Products Name	U.P.\$
120160	Ratcheting Screwdriver Handle	271

# LCP Locking Common Instrument

## Locking Threaded Drill Guide

Veterinary Use Only

Unit mm



Code	Products Name	Specification	Use Screw	U.P.\$
110189	Locking Threaded Drill Guide	0.8/1.2mm	AO 1.2mm Locking Screws	90.3
110188	Locking Threaded Drill Guide	1.1/1.5mm	AO 1.5mm Locking Screws	90.3
110187	Locking Threaded Drill Guide	1.5/2.0mm	AO 2.0mm Locking Screws	90.3
100186	Locking Threaded Drill Guide	1.8/2.4mm	AO 2.4mm Locking Screws	77.4
100185	Locking Threaded Drill Guide	2.0/2.7mm	AO 2.7mm Locking Screws	77.4
110180	Locking Threaded Drill Guide	2.4/3.0mm	AO 3.0mm Locking Screws	77.4
100184	Locking Threaded Drill Guide	2.8/3.5mm	AO 3.5mm Locking Screws	67.7
110183	Locking Threaded Drill Guide	4.3/5.0mm	AO 5.0mm Locking Screws	67.7

## Torque Limiting Attachment

Veterinary Use Only

Unit Nm



Code	Products Name	Specification	U.P.\$
511.777	Torque Limiting Attachment	AO QC 0.4Nm	319.4
511.776	Torque Limiting Attachment	AO QC 0.8Nm	319.4
511.773	Torque Limiting Attachment	AO QC 1.5Nm	271

## Thread Bender

Veterinary Use Only

Unit mm



Code	Products Name	Specification	U.P.\$
03.114.003	Thread Bender	1.5mm	58.1
329.921	Thread Bender	2.0mm	58.1
329.922	Thread Bender	2.4/2.7mm	58.1
324.023	Thread Bender	3.5mm	58.1

## Push-Pull Reduction Device

Veterinary Use Only

Unit mm



Code	Products Name	Specification	U.P.\$
5.006	Push-Pull Reduction Device	3.5mm	74.2
6.006	Push-Pull Reduction Device	5.0mm	74.2





# LCP Instrument Set



## Lock Instruments Set

### 1.5/2.0/2.4mm Lock Instruments Set

Code	Products Name/Specification	Quantity
000018	1.5/2.0/2.4mm Lock Instruments Set	
110188	1.5mm Locking Threaded Drill Guide	2
110187	2.0mm Locking Threaded Drill Guide	2
100186	2.4mm Locking Threaded Drill Guide	2
PRW125	Small Temporary Plate Holding Pins	2
A32QC11	1.1mm AO Quick Fit Drill Bits	1
A32QC15	1.5mm AO Quick Fit Drill Bits	1
A32QC18	1.8mm AO Quick Fit Drill Bits	1
A32QC20	2.0mm AO Quick Fit Drill Bits	1
110232	T4 Star Drive Insert AO QC	1
100232	T6 Star Drive Insert AO QC	1
100231	T8 Star Drive Insert AO QC	1
100226	Screwdriver AO QC	1
100217	Screw holding Sleeve For 1.5/2.0/2.4mm Screws	1
100239b	Φ3mm Countersink AO Quick Fit Coupling	1
100240	Φ4mm Countersink AO Quick Fit Coupling	1
100170	AO Quick Coupling Taps	1
100171	AO Quick Coupling Taps	1
100172	AO Quick Coupling Taps	1
329.921	2.0mm Thread Bender	2
329.922	2.4/2.7mm Thread Bender	2
100178	1.1/1.5mm Combination Drill	1
100179	1.5/2.0mm Combination Drill	1
100180	1.8/2.4mm Combination Drill	1
100188	1.5/2.0mm Universal Drill Guide	1
100189	1.8/2.4mm Universal Drill Guide	1
100236	Depth gauge 0-30mm	1
100159	AO T Tap Handle	1
110160	AO QC Handle	1
511.777	0.4Nm Torque Limiting Aachment	1
511.776	0.8Nm Torque Limiting Aachment	1
100065	AO1.5/2.0/2.4 Bending Iron	1
100234	Screw Holding Forceps	1
18.02	Mini LCP Instrument Sterilization Case	1

U.P.\$ 3033.5

### 2.7/3.5mm Lock Instruments Set

Code	Products Name/Specification	Quantity
000019	2.7/3.5mm Lock Instruments Set	
100185	2.7mm Locking Threaded Drill Guide	2
100184	3.5mm Locking Threaded Drill Guide	2
PRW150	Large Temporary Plate Holding Pins	2
A32QC20	2.0mm AO Quick Fit Drill Bits	1
A32QC25	2.5mm AO Quick Fit Drill Bits	1
A32QC28	2.8mm AO Quick Fit Drill Bits	1
A32QC35	3.5mm AO Quick Fit Drill Bits	1
100231	T8 StarDrive Screwdriver shaft	1
100230	T15 StarDrive Screwdriver shaft	1
100228	2.5mm Hex Screwdriver AO QC	1
100220	Screw holding Sleeve For 2.7/3.0/3.5/4.0mm Screws	1
100242	Countersink AO Quick Fit Coupling	1
100173	AO Quick Coupling Taps	1
100174	AO Quick Coupling Taps	1
324.023	3.5mm Thread Bender	2
329.922	2.4/Thread Bender	2
100181	2.0/2.7mm Combination Drill	1
100192	2.0mm Parallel Drill Guide And Drill Sleeve	1
100182	2.5/3.5mm Combination Drill	1
100190	2.0/2.7mm Universal Drill Guide	1
100191	2.5/3.5mm Universal Drill Guide	1
100237	Depth gauge 0-50mm	1
511.773	1.5Nm Torque Limiting Aachment	1
511.776	0.8Nm Torque Limiting Aachment	1
100159	AO T Tap Handle	1
110160	AO QC Handle	1
100066	2.7/3.5mm Bending Iron	1
5.006	3.5mm Push-Pull Reduction Device	1
100233	Screw Holding Forceps	1
19.02	Small LCP Instrument Sterilization Case	1

U.P.\$ 2599.5

# LCP Plates Set

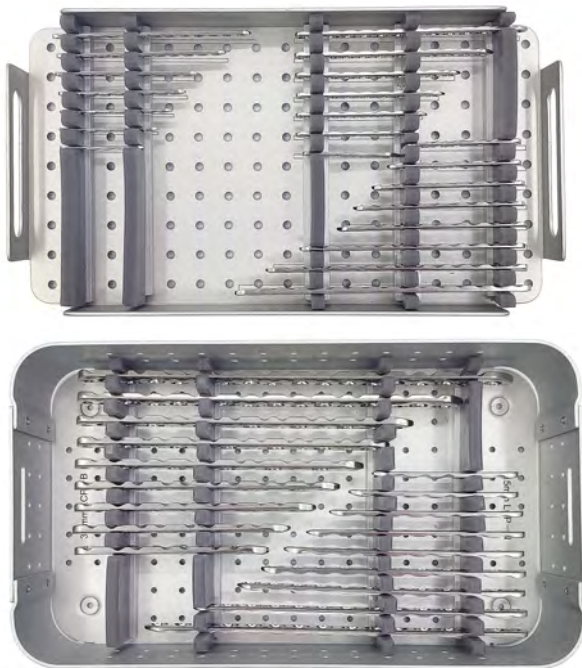

## LCP Plates Set 2.0/2.4/2.7/3.5mm

Code	Products Name/Specification	Quantity
	LCP Plates Set 2.0/2.4/2.7/3.5mm	
VP4012.06	2.0mm LCP Bone Plates 6 Holes 41mm	1
VP4012.07	2.0mm LCP Bone Plates 7 Holes 48mm	1
VP4012.08	2.0mm LCP Bone Plates 8 Holes 55mm	1
VP4012.09	2.0mm LCP Bone Plates 9 Holes 62mm	1
VP4012.10	2.0mm LCP Bone Plates 10 Holes 69mm	1
VP4012.12	2.0mm LCP Bone Plates 12 Holes 83mm	1
VP4012.14	2.0mm LCP Bone Plates 14 Holes 97mm	1
VP4021.06	2.4mm LCP Bone Plates 6 Holes 48mm	1
VP4021.07	2.4mm LCP Bone Plates 7 Holes 56mm	1
VP4021.08	2.4mm LCP Bone Plates 8 Holes 64mm	1
VP4022.09	2.4mm LCP Bone Plates 9 Holes 72mm	1
VP4022.10	2.4mm LCP Bone Plates 10 Holes 80mm	1
VP4022.12	2.4mm LCP Bone Plates 12 Holes 96mm	1
VP4022.14	2.4mm LCP Bone Plates 14 Holes 112mm	1
VP4031.06	2.7mm LCP Bone Plates 6 Holes 54mm	1
VP4031.07	2.7mm LCP Bone Plates 7 Holes 63mm	1
VP4031.08	2.7mm LCP Bone Plates 8 Holes 72mm	1
VP4031.09	2.7mm LCP Bone Plates 9 Holes 81mm	1
VP4031.10	2.7mm LCP Bone Plates 10 Holes 90mm	1
VP4031.12	2.7mm LCP Bone Plates 12 Holes 108mm	1
VP4031.14	2.7mm LCP Bone Plates 14 Holes 126mm	1

Code	Products Name/Specification	Quantity
VP4031.16	2.7mm LCP Bone Plates 16 Holes 144mm	1
VP4041.06	3.5mm LCP Bone Plates Narrow 6 Holes 79mm	1
VP4041.07	3.5mm LCP Bone Plates Narrow 7 Holes 92mm	1
VP4041.08	3.5mm LCP Bone Plates Narrow 8 Holes 105mm	1
VP4041.09	3.5mm LCP Bone Plates Narrow 9 Holes 118mm	1
VP4041.10	3.5mm LCP Bone Plates Narrow 10 Holes 131mm	1
VP4041.11	3.5mm LCP Bone Plates Narrow 11 Holes 144mm	1
VP4041.12	3.5mm LCP Bone Plates Narrow 12 Holes 157mm	1
VP4041.14	3.5mm LCP Bone Plates Narrow 14 Holes 183mm	1
VP4041.16	3.5mm LCP Bone Plates Narrow 16 Holes 209mm	1
VP4045.08	3.5mm LCP Bone Plates Broad 8 Holes 107mm	1
VP4045.09	3.5mm LCP Bone Plates Broad 9 Holes 120mm	1
VP4045.10	3.5mm LCP Bone Plates Broad 10 Holes 133mm	1
VP4045.11	3.5mm LCP Bone Plates Broad 11 Holes 146mm	1
VP4045.12	3.5mm LCP Bone Plates Broad 12 Holes 159mm	1
VP4045.13	3.5mm LCP Bone Plates Broad 13 Holes 172mm	1
VP4045.14	3.5mm LCP Bone Plates Broad 14 Holes 185mm	1
VP4045.16	3.5mm LCP Bone Plates Broad 16 Holes 211mm	1
VP4045.18	3.5mm LCP Bone Plates Broad 18 Holes 237mm	1
21.02	LCP Plates Set Sterilization Case	1

U.P.\$ 6267.8

# BIORTHO-SOP Locking Plate



## 2.0mm SOP Locking Plate

Veterinary Use Only Stainless Steel 316LVM

Unit mm



Code	Width	Thickness	Hole Distance	Holes	L	U.P.\$
SOP2020	6	3.5	8	20	162	327

Matching Screws ● CSTT20

## 2.7mm SOP Locking Plate

Veterinary Use Only Stainless Steel 316LVM

Unit mm



Code	Width	Thickness	Hole Distance	Holes	L	U.P.\$
SOP2720	7	4.0	8	20	162	327

Matching Screws ● CSTT27

## 3.5mm SOP Locking Plate

Veterinary Use Only Stainless Steel 316LVM

Unit mm



Code	Width	Thickness	Hole Distance	Holes	L	U.P.\$
SOP3520	9	6.0	12	20	244	327

Matching Screws ● CSTT35

# BIORTHO SOP Plate Bender

## 2.0mm SOP Plate Bender

Veterinary Use Only Stainless Steel 316LVM

Unit mm



Code	Specification	L	U.P.\$
SOP001L	2.0 Left	130mm	179
SOP001R	2.0 Right	130mm	179



## 2.7mm SOP Plate Bender

Veterinary Use Only Stainless Steel 316LVM

Unit mm



Code	Specification	L	U.P.\$
SOP002L	2.7 Left	200mm	179
SOP002R	2.7 Right	200mm	179



## 3.5mm SOP Plate Bender

Veterinary Use Only Stainless Steel 316LVM

Unit mm



Code	Specification	L	U.P.\$
SOP003L	3.5 Left	250mm	179
SOP003R	3.5 Right	250mm	179



## SOP Drill Guide

Veterinary Use Only Stainless Steel 316LVM

Unit mm



Code	Specification	U.P.\$
SOP004	1.5/2.0	239
SOP005	2.0/2.7	239
SOP006	2.5/3.5	239

# Titanium Mini Plates

## 1.1mm 'T' Plates

Veterinary Use Only

Titanium Grade 5

Unit mm

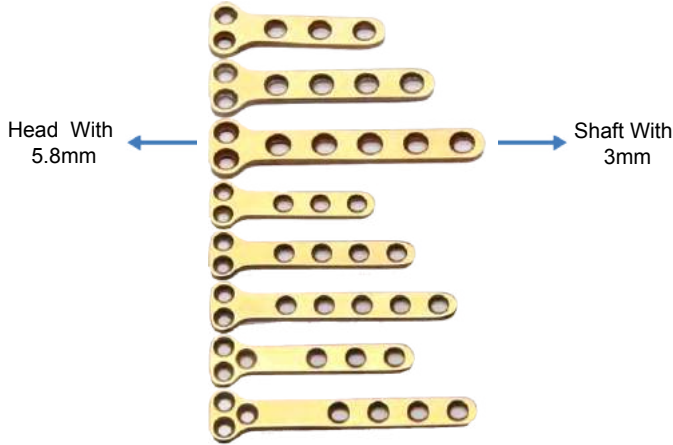

Code	Specification	Holes	Thickness	L	U.P.\$
T101016	A	5	1.0	16	51.6
T101020	A	6	1.0	20	58.1
T101024	A	7	1.0	24	64.5
T101018	B	5	1.0	18	58.1
T101022	B	6	1.0	22	64.5
T101026	B	7	1.0	26	67.7
T101021	C	6	1.0	21	61.3
T101027	C	7	1.0	27	67.7

Matching Screws ● TCS11



## 1.1mm Cuttable Plate

Veterinary Use Only

Titanium Grade 5

Unit mm

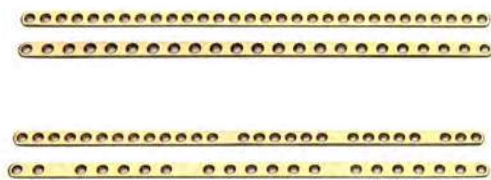

Code	Width	Thickness	Holes	L	U.P.\$
CP10390	3	1.0	30	90	90
CP10391	3	1.0	23	91	90

Code	Width	Thickness	Holes	L	U.P.\$
CP1039027	3	1.0	27	90	90
CP1039120	3	1.0	20	91	106.1

Matching Screws ● TCS11

## 1.1mm Cuttable Malleable Plate

Veterinary Use Only

Titanium Grade 5

Unit mm



Code	Width	Thickness	Holes	L	U.P.\$
CM10390	3	1.0	30	90	122.3

Matching Screws ● TCS11

# Titanium Cuttable Malleable Plate

## 1.1mm Double T Head Cuttable Malleable Veterinary Use Only Titanium Grade 5



Unit mm

Code	Width	Thickness	Holes	L	U.P.\$
MPT1039030	3	1.0	30	90	122.3

Matching Screws ● TCS11

## 1.5mm Double T Head Cuttable Malleable Veterinary Use Only Titanium Grade 5



Unit mm

Code	Width	Thickness	Hole Distance	Holes	L	U.P.\$
DTP1504A	4	1.5	5	32	148	109.7
DTP1504B	4	1.5	5	32	152	109.7
DTP1504C	4	1.5	5	30	148	109.7

Matching Screws ● TCS15

## 2.0mm Double T Head Cuttable Malleable Veterinary Use Only Titanium Grade 5

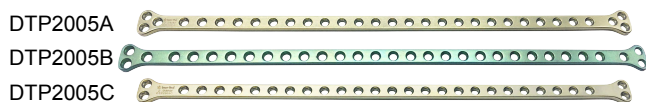

Unit mm

Code	Width	Thickness	Hole Distance	Holes	L	U.P.\$
DTP2005A	5	1.8	5.5	31	160	109.7
DTP2005B	5	1.8	5.5	31	164	109.7
DTP2005C	5	1.8	5.5	29	160	109.7

Matching Screws ● TCS20

## 2.4mm Double T Head Cuttable Malleable Veterinary Use Only Titanium Grade 5



Unit mm

Code	Width	Thickness	Hole Distance	Holes	L	U.P.\$
DTP2465A	6.5	2.2	7	29	188	109.7
DTP2465B	6.5	2.2	7	29	192	109.7
DTP2465C	6.5	2.2	7	27	188	109.7

Matching Screws ● TCS24

# Titanium Reconstruction Plate

## 1.5mm Titanium Reconstruction Plate

Veterinary Use Only

Titanium Grade 5

Unit mm



Code	Width	Thickness	Hole Distance	Holes	L	U.P.\$
TCM154020	4	1.5	5	20	100	74.2

Matching Screws ● TCS15

## 2.0mm Titanium Reconstruction Plate

Veterinary Use Only

Titanium Grade 5

Unit mm



Code	Width	Thickness	Hole Distance	Holes	L	U.P.\$
TCM205020	5	1.8	5	20	100	67.7

Matching Screws ● TCS20

## 2.4mm Titanium Reconstruction Plate

Veterinary Use Only

Titanium Grade 5

Unit mm



Code	Width	Thickness	Hole Distance	Holes	L	U.P.\$
TCM246525	6.5	2.2	6	25	161	80.6

Matching Screws ● TCS24

## 2.7mm Titanium Reconstruction Plate

Veterinary Use Only

Titanium Grade 5

Unit mm



Code	Width	Thickness	Hole Distance	Holes	L	U.P.\$
TCM272020	8	2.5	8	20	160	77.4

Matching Screws ● TCS27

# ALPS Locking Plate

ALPS Locking Plate

Veterinary Use Only

Titanium Grade 5

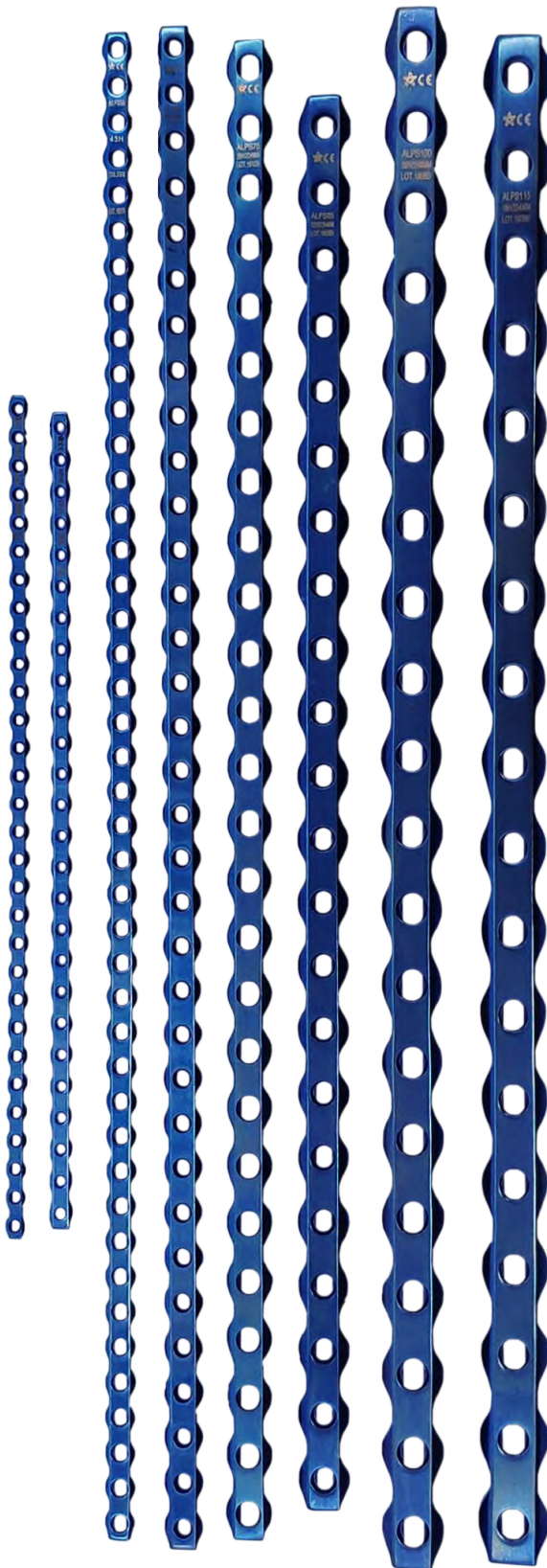

Unit mm

Code	With	Thickness	Holes	L	U.P.\$
ALPS35	3.5	1.2	30	135	206.5
ALPS42	4.2	1.5	26	130	190.3
ALPS50	5.0	1.8	43	236.5	206.5
ALPS65	6.5	2.0	34	238	190.3
ALPS75	7.5	2.5	26	234	190.3
ALPS85	8.5	2.8	22	234	180.6
ALPS100	10	3.5	20	240	174.2
ALPS115	11.5	3.8	18	234	174.2
ALPS50S	5.0	1.8	20	110	78
ALPS65S	6.5	1.8	16	112	78
ALPS75S	7.5	2.5	16	162	74
ALPS85S	8.5	2.8	16	160	74

Matching Screws ● ALPS35/42 For B16 Locking Nail, TCS11 Cortex Nail

Matching Screws ● ALPS50/65 For B24 Locking Nail, TCS15 Cortex Nail

Matching Screws ● ALPS75/85 For B32 Locking Nail, TCS24 Cortex Nail

Matching Screws ● ALPS100/115 For B40 Locking Nail, TCS27 Cortex Nail



## ALPS T Locking Plate

Veterinary Use Only

Titanium Grade 5



Unitmm

Code	Head With	Shaft With	Thickness	Holes	L	U.P.\$
ALPS35T2	8	3.5	1.2	Head 2/Shaft 5	30	125.8
ALPS42T2	9	4.2	1.5	Head 2/Shaft 5	33	125.8
ALPS50T2	11	5.0	1.8	Head 2/Shaft 5	38	109.7
ALPS65T2	13	6.5	2.0	Head 2/Shaft 5	48	109.7
ALPS75T2	16	7.5	2.5	Head 2/Shaft 5	59	109.7
ALPS85T2	19	8.5	2.8	Head 2/Shaft 5	68	109.7
ALPS35T3	6.5	3.5	1.2	Head 3/Shaft 5	31	141.9
ALPS42T3	7	4.2	1.5	Head 3/Shaft 5	34	141.9
ALPS50T3	9	5.0	1.8	Head 3/Shaft 5	39	141.9

- Matching Screws ● ALPS35/42 For B16 Locking Nail, TCS11 Cortex Nail
- Matching Screws ● ALPS50/65 For B24 Locking Nail, TCS15 Cortex Nail
- Matching Screws ● ALPS75/85 For B32 Locking Nail, TCS24 Cortex Nail
- Matching Screws ● ALPS10/115 For B40 Locking Nail, TCS27 Cortex Nail

## Φ1.1mm Locking Drill Guide

Veterinary Use Only

Unit mm



Code	Products Name	Specification	U.P.\$
10.02	Φ1.1mm Locking Drill Guide	1.1/B1.6	45.2

## Φ0.8/1.1mm Netrual Drill Guide

Veterinary Use Only

Unit mm



Code	Products Name	Specification	U.P.\$
100187	Netrual Drill Guide	0.8/1.1	67.7

## 1.1mm Cruciform Screwdriver

Veterinary Use Only

Unit mm



Code	Products Name	U.P.\$
SDIN11	1.1mm Cruciform Screwdriver	57.7
SDIN12	1.1mm Cruciform Screwdriver Fiber Handle	29

# ALPS-3 Titanium Locking System

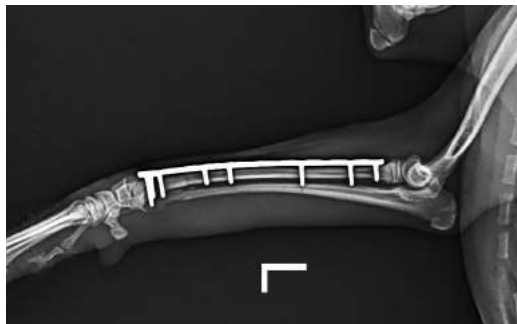

## ALPS-3 Titanium Locking System

Code	Products Name/Specification	Quantity
000010	ALPS-3 Titanium Locking System	
A32A08	Φ0.8 Drill Bit	2
A32A11	Φ1.1 Drill Bit	2
10.02	Φ1.1mm Locking Drill Guide	1
100187	Φ0.8/1.1mm Neutral Drill Guide	1
SDIN11	1.1mm Cruciform Screwdriver	1
T101016	1.1mm 'T' Plates5H 16mm	1
T101020	1.1mm 'T' Plates6H 20mm	1
T101024	1.1mm 'T' Plates7H 24mm	1
T101018	1.1mm 'T' Plates5H 18mm	1
T101022	1.1mm 'T' Plates6H 22mm	1
T101026	1.1mm 'T' Plates7H 26mm	1
T101021	1.1mm 'T' Plates6H 21mm	1
T101027	1.1mm 'T' Plates7H 27mm	1
CP10390	Cutable Plate 1.1mm 30 Holes 90mm Long	1
CP10391	Cutable Plate 1.1mm 23 Holes 91mm Long	1
CM10390	Cutable Malleable Plate 1.1mm 30Holes 90mm Long	1
CP1039027	Cutable Plate 1.1mm 27 Holes 90mm Long	1

Code	Products Name/Specification	Quantity
ALPS35	Locking Plate 3.5mm Width 1.2mm Thick 30H 135mm Long	1
ALPS42	Locking Plate 4.2mm Width 1.5mm Thick 26H 130mm Long	1
B1604	B1.6X4mm Locking Screw	6-10 PCS
B1605	B1.6X5mm Locking Screw	6-10 PCS
B1606	B1.6X6mm Locking Screw	6-10 PCS
B1607	B1.6X7mm Locking Screw	6-10 PCS
B1608	B1.6X8mm Locking Screw	6-10 PCS
B1610	B1.6X10mm Locking Screw	6-10 PCS
TCS1104	1.1X4mm Cortical Screws Self-Tapping	6-10 PCS
TCS1105	1.1X5mm Cortical Screws Self-Tapping	6-10 PCS
TCS1106	1.1X6mm Cortical Screws Self-Tapping	6-10 PCS
TCS1107	1.1X7mm Cortical Screws Self-Tapping	6-10 PCS
TCS1108	1.1X8mm Cortical Screws Self-Tapping	6-10 PCS
TCS1109	1.1X9mm Cortical Screws Self-Tapping	6-10 PCS
TCS1110	1.1X10mm Cortical Screws Self-Tapping	6-10 PCS
TCS1112	1.1X12mm Cortical Screws Self-Tapping	6-10 PCS
10.01	Caddy	1

Standard Set U.P.\$ 2452

Full Set U.P.\$ 2928

# ALPS-5 Titanium Locking System



## ALPS-5 Titanium Locking System

Code	Products Name/Specification	Quantity
000015	ALPS-5 Titanium Locking System	
A32QC11	AO drill bit 1.1mm	1
A32QC15	AO drill bit 1.5mm	1
A32QC18	AO drill bit 1.8mm	1
100208A	1.8mm Drill Stops&Wrench	1
15.03	1.1mm Threaded Drill Guide	1
15.04	1.8mm Locking Drill Guide	1
15.05	1.1mm Compression Drill Guide	1
15.06	1.1mm/1.5mm Netraul Drill Guide	1
100160	AO QC Handle	1
100236	Depth gauge 30mm	1
100234	Screw Holder	1
100232	AO QC T6 Star Screwdriver	1
15.07	Alp 5/6.5 Plate Bender	1
ALPS50	ALP-5 Locking Plate 43 Holes	1
ALPS65	ALP-6.5 Locking Plate 34 Holes	1
B2405	B2.4X5mm Locking Screw	6-10 PCS
B2406	B2.4X6mm Locking Screw	6-10 PCS
B2408	B2.4X8mm Locking Screw	6-10 PCS
B2410	B2.4X10mm Locking Screw	6-10 PCS
B2412	B2.4X12mm Locking Screw	6-10 PCS

Code	Products Name/Specification	Quantity
B2414	B2.4X14mm Locking Screw	6-10 PCS
B2416	B2.4X16mm Locking Screw	6-10 PCS
B2418	B2.4X18mm Locking Screw	6-10 PCS
TCS1506	1.5X6mm Cortical Screws Self-Tapping	2-8 PCS
TCS1507	1.5X7mm Cortical Screws Self-Tapping	2-8 PCS
TCS1508	1.5X8mm Cortical Screws Self-Tapping	2-8 PCS
TCS1509	1.5X9mm Cortical Screws Self-Tapping	2-8 PCS
TCS1510	1.5X10mm Cortical Screws Self-Tapping	2-8 PCS
TCS1512	1.5X12mm Cortical Screws Self-Tapping	2-8 PCS
TCS1514	1.5X14mm Cortical Screws Self-Tapping	2-8 PCS
TCS1516	1.5X16mm Cortical Screws Self-Tapping	2-8 PCS
TCS1518	1.5X18mm Cortical Screws Self-Tapping	2-8 PCS
TCS1520	1.5X20mm Cortical Screws Self-Tapping	2-8 PCS
TCS1522	1.5X22mm Cortical Screws Self-Tapping	2-8 PCS
TCS1524	1.5X24mm Cortical Screws Self-Tapping	2-8 PCS
TCS1526	1.5X26mm Cortical Screws Self-Tapping	2-8 PCS
TCS1528	1.5X28mm Cortical Screws Self-Tapping	2-8 PCS
TCS1530	1.5X30mm Cortical Screws Self-Tapping	2-8 PCS
15.01	Implants Tray	1
15.02	Sterilization Box	1

Standard Set U.P.\$ 2056.7

Full Set U.P.\$ 2875.1

# ALPS-8 Titanium Locking System



## ALPS-8 Titanium Locking System

Code	Products Name/Specification	Quantity
000016	ALPS-8 Titanium Locking System	
A32QC18	AO $\Phi$ 1.8mm QC Drill Bit	1
A32QC25	AO $\Phi$ 2.5mm QC Drill Bit	1
100208B	2.5mm Drill Bit Depth Limited Block	1
16.03	1.8mm Threaded Drill Sleeve	1
16.04	2.5mm Locking Sleeve	1
16.05	1.8mm Compression Drill Guide	1
16.06	1.8mm/2.5mm Neutral Sleeve	1
100160	AO QC Handle	1
100237	Depth gauge 50mm	1
100233	Screw Holder	1
1002310	AO QC T10 Star Screwdriver	1
16.07	ALPS 7.5/8.5 Plate Bender	1
ALPS75	ALPS 7.5 Locking Plate 26Holes	1
ALPS85	ALPS 8.5 Locking Plate 22Holes	1
B3208	B3.2X8mm Locking Screw	6-10 PCS
B3210	B3.2X10mm Locking Screw	6-10 PCS
B3212	B3.2X12mm Locking Screw	6-10 PCS
B3214	B3.2X14mm Locking Screw	6-10 PCS

Code	Products Name/Specification	Quantity
B3216	B3.2X16mm Locking Screw	6-10 PCS
B3218	B3.2X18mm Locking Screw	6-10 PCS
B3220	B3.2X20mm Locking Screw	6-10 PCS
B3222	B3.2X22mm Locking Screw	6-10 PCS
TCS2410	2.4X10mm Cortical Screws Self-Tapping	2-6 PCS
TCS2412	2.4X12mm Cortical Screws Self-Tapping	2-6 PCS
TCS2414	2.4X14mm Cortical Screws Self-Tapping	2-6 PCS
TCS2416	2.4X16mm Cortical Screws Self-Tapping	2-6 PCS
TCS2418	2.4X18mm Cortical Screws Self-Tapping	2-6 PCS
TCS2420	2.4X20mm Cortical Screws Self-Tapping	2-6 PCS
TCS2422	2.4X22mm Cortical Screws Self-Tapping	2-6 PCS
TCS2424	2.4X24mm Cortical Screws Self-Tapping	2-6 PCS
TCS2426	2.4X26mm Cortical Screws Self-Tapping	2-6 PCS
TCS2428	2.4X28mm Cortical Screws Self-Tapping	2-6 PCS
TCS2430	2.4X30mm Cortical Screws Self-Tapping	2-6 PCS
TCS2432	2.4X32mm Cortical Screws Self-Tapping	2-6 PCS
16.01	Implant Tray	1
16.02	Sterilization Box	1

Standard Set U.P.\$ 1888.4

Full Set U.P.\$ 2460.8

# ALPS-10 Titanium Locking System



## ALPS-10 Titanium Locking System

Code	Products Name/Specification	Quantity
000017	ALPS-10 Titanium Locking System	
A32QC20	2.0 AO QC Drill Bit	1
A32QC27	2.7 AO QC Drill Bit	1
A32QC32	3.2 AO QC Drill Bit	1
100208C	Φ3.2mm Drill Depth Limited Block	1
17.03	Φ2.0mm Threaded Sleeve	1
17.04	Φ3.2mm Locking Sleeve	1
17.06	Φ2.0mm Compression Sleeve	1
17.05	2.0mm/2.7mm Neutral Drill Guide	1
100160	AO QC Handle	1
100237	Depth gauge 50mm	1
100233	Screw Holding Forceps For 2.7/3.0/3.5/4.0 Screws	1
1002310	AO QC T10 Star Screwdriver	1
17.07	ALPS10/11.5 Plate Bender	1
ALPS100	ALPS10 Locking Plate 20Holes	1
ALPS115	ALPS11.5 Locking Plate 18Holes	1
B4010	B4.0X10mm Locking Screw	6-9 PCS
B4012	B4.0X12mm Locking Screw	6-9 PCS
B4014	B4.0X14mm Locking Screw	6-9 PCS
B4016	B4.0X16mm Locking Screw	6-9 PCS
B4018	B4.0X18mm Locking Screw	6-9 PCS
B4020	B4.0X20mm Locking Screw	6-9 PCS

Code	Products Name/Specification	Quantity
B4022	B4.0X22mm Locking Screw	6-9 PCS
B4024	B4.0X24mm Locking Screw	6-6 PCS
B4026	B4.0X26mm Locking Screw	6-6 PCS
B4028	B4.0X28mm Locking Screw	6-6 PCS
B4030	B4.0X30mm Locking Screw	6-6 PCS
B4032	B4.0X32mm Locking Screw	6-6 PCS
B4034	B4.0X34mm Locking Screw	6-6 PCS
TCS2712	2.7X12mm Cortical Screws Self-Tapping	2-6 PCS
TCS2714	2.7X14mm Cortical Screws Self-Tapping	2-6 PCS
TCS2716	2.7X16mm Cortical Screws Self-Tapping	2-6 PCS
TCS2718	2.7X18mm Cortical Screws Self-Tapping	2-6 PCS
TCS2720	2.7X20mm Cortical Screws Self-Tapping	2-6 PCS
TCS2722	2.7X22mm Cortical Screws Self-Tapping	2-6 PCS
TCS2724	2.7X24mm Cortical Screws Self-Tapping	2-6 PCS
TCS2726	2.7X26mm Cortical Screws Self-Tapping	2-6 PCS
TCS2728	2.7X28mm Cortical Screws Self-Tapping	2-6 PCS
TCS2730	2.7X30mm Cortical Screws Self-Tapping	2-6 PCS
TCS2732	2.7X32mm Cortical Screws Self-Tapping	2-6 PCS
TCS2734	2.7X34mm Cortical Screws Self-Tapping	2-6 PCS
17.02	Implant Tray	1
17.01	Sterilization Box	1

Standard Set U.P.\$ 2309.9

Full Set U.P.\$ 2777.5

# ALPS Related Instruments

## Threaded Drill Guide

Veterinary Use Only



Unit mm

Code	Products Name	Specification	U.P.\$
15.03	Threaded Drill Guide	1.1mm	45.2
16.03	Threaded Drill Guide	1.8mm	45.2
17.03	Threaded Drill Guide	2.0mm	45.2

## Locking Drill Guide

Veterinary Use Only



Unit mm

Code	Products Name	Specification	U.P.\$
15.04	Locking Drill Guide	1.8mm	41.9
16.04	Locking Drill Guide	2.5mm	41.9
17.04	Locking Drill Guide	3.2mm	41.9

## Compression Drill Guide

Veterinary Use Only



Unit mm

Code	Products Name	Specification	U.P.\$
15.05	Compression Drill Guide	1.1mm	45.2
16.05	Compression Drill Guide	1.8mm	45.2
17.06	Compression Drill Guide	2.0mm	45.2

## Neutral Drill Guide

Veterinary Use Only



Unit mm

Code	Products Name	Specification	U.P.\$
15.06	Neutral Drill Guide	1.1mm/1.5mm	51.6
16.06	Neutral Drill Guide	1.8mm/2.5mm	51.6
17.05	Neutral Drill Guide	2.0mm/2.7mm	45.2

## ALPS Bending Iron

Veterinary Use Only

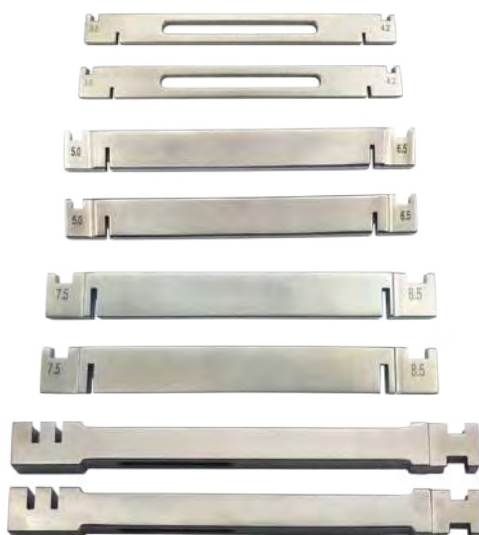

Unit mm

Code	Products Name	Specification	U.P.\$
MPB002	ALPS Mini Bender	3.5/4.2	93.5
15.07	ALPS Bending Iron	5/6.5	77.4
16.07	ALPS Bending Iron	7.5/8.5	77.4
17.07	ALPS Bending Iron	10/11.5	77.4

# TPLO Plate System

## 1.5mm TPLO Plates

Veterinary Use Only Stainless Steel 316LVM



Unit mm

Code	Specification	Holes	Thickness	L	U.P.\$
VP4410.L3	1.5 Left	Near End 3 Far End 3	2.0	26	169
VP4410.R3	1.5 Right	Near End 3 Far End 3	2.0	26	169

Matching Screws ● LS15, TCS15



## 2.0mm TPLO Plates

Veterinary Use Only Stainless Steel 316LVM



Unit mm

Code	Specification	Holes	Thickness	L	U.P.\$
VP4405.L3	2.0 Left	Near End 3 Far End 3	2.3	30	149
VP4405.R3	2.0 Right	Near End 3 Far End 3	2.3	30	149

Matching Screws ● LS20, CSST20, CSST15/CSTT15

## 2.4mm TPLO Plates

Veterinary Use Only Stainless Steel 316LVM



Unit mm

Code	Specification	Holes	Thickness	L	U.P.\$
VP4404.L3	2.4 Left	Near End 3 Far End 3	2.3	35	149
VP4404.R3	2.4 Right	Near End 3 Far End 3	2.3	35	149

Matching Screws ● LS24, CSST24/CSTT24

## 2.7mm TPLO Plates

Veterinary Use Only Stainless Steel 316LVM



Unit mm

Code	Specification	Holes	Thickness	L	U.P.\$
VP4400.L3	2.7 Left	Near End 3 Far End 3	2.5	46	149
VP4400.R3	2.7 Right	Near End 3 Far End 3	2.5	46	149

Matching Screws ● LS27, CSST27/CSTT27

# TPLO Plate System

## 3.0mm TPLO Plates

Veterinary Use Only Stainless Steel 316LVM



Unit mm

Code	Specification	Holes	Thickness	L	U.P.\$
VP4406.L3	3.0 Left	Near End 3 Far End 3	3.0	50	169
VP4406.R3	3.0 Right	Near End 3 Far End 3	3.0	50	169

Matching Screws ● LS30, CSST27/CSTT27

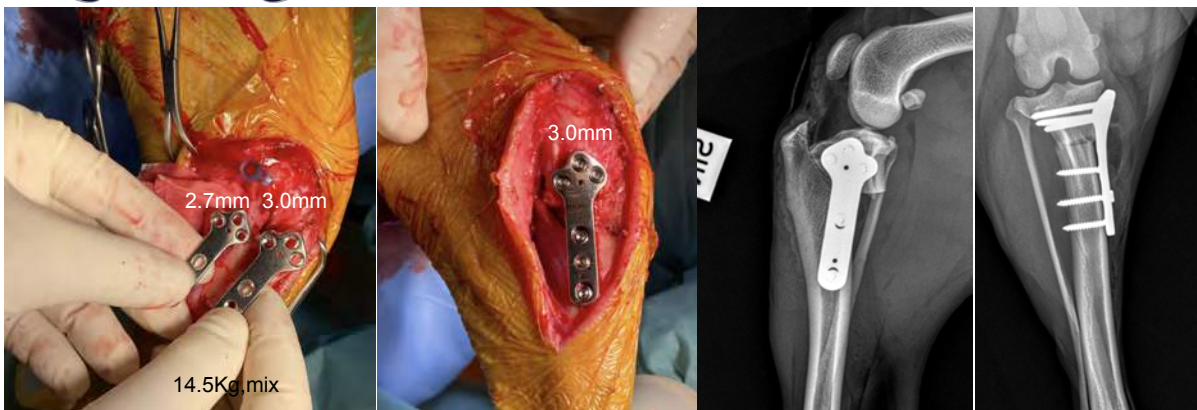

## 3.5mm Small TPLO Plate

Veterinary Use Only Stainless Steel 316LVM



Unit mm

Code	Specification	Holes	Thickness	L	U.P.\$
VP4403.L3	3.5 Left	Head 3/Shaft 3	3.7	55	149
VP4403.R3	3.5 Right	Head 3/Shaft 3	3.7	55	149

Matching Screws ● LS35, CSST35/CSTT35

## 3.5mm TPLO Plate

Veterinary Use Only Stainless Steel 316LVM



Unit mm

Code	Specification	Holes	Thickness	L	U.P.\$
VP4401.L3	3.5 Left	Head 3/Shaft 3	3.7	64	149
VP4401.R3	3.5 Right	Head 3/Shaft 3	3.7	64	149

● LS35, CSST35/CSTT35



# TPLO Plate System

## 3.5mm Broad TPLO Plate

Veterinary Use Only Stainless Steel 316LVM



Unit mm

Code	Specification	Holes	Thickness	L	U.P.\$
VP4402.L4	3.5 Left	Head 4/Shaft 4	3.7	80	169
VP4402.R4	3.5 Right	Head 4/Shaft 4	3.7	80	169

● LS35, CSST35/CSTT35



## 5.0mm JUMBO TPLO Plate

Veterinary Use Only Stainless Steel 316LVM



Unit mm

Code	Specification	Holes	Thickness	L	U.P.\$
VP4407.L4	5.0 Left	Head 4/Shaft 4	4.8	110	264
VP4407.R4	5.0 Right	Head 4/Shaft 4	4.8	110	264

Matching Screws ● LS50, CSST45

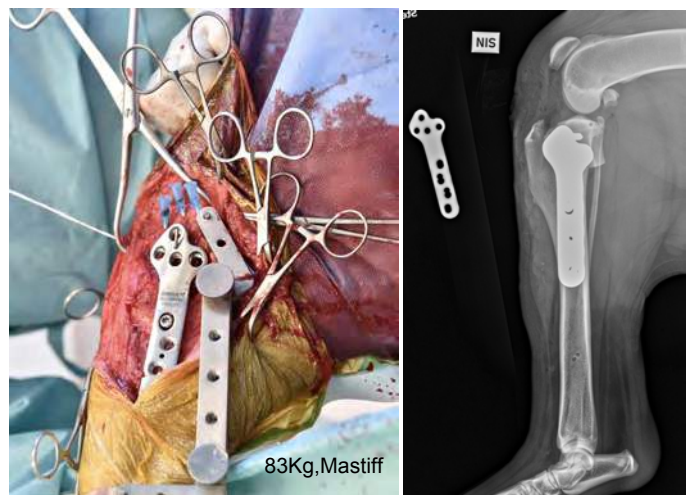

## Tibial Plateau Reduction Threaded Pin

Veterinary Use Only Stainless Steel 316LVM



Unit mm

Code	Specification	U.P.\$
VW1003.15	1.5mmX45mmX150mm	11
VW1203.15	2.0mmX65mmX200mm	11

# TPLO Surgery Instruments

## Mini TPLO Jig

Veterinary Use Only



Code	Products Name	Specification	U.P.\$
VQ0002.00	TPLO Jig	Mini	916.1



Code	Products Name	Specification	U.P.\$
VQ0002.01	TPLO Jig Straight Legs	Mini	122.6

## Standard TPLO Jig

Veterinary Use Only



Code	Products Name	Specification	U.P.\$
VQ0001.00	TPLO Jig	Standard	812.9



Code	Products Name	Specification	U.P.\$
VQ0001.01	TPLO Jig Straight Legs	Standard	138.7



Code	Products Name	Specification	U.P.\$
VQ0001.24	Saw Guides	24mm	77.4
VQ0001.27	Saw Guides	27mm	77.4
VQ0001.30	Saw Guides	30mm	77.4

For Standard TPLO Jig



Code	Products Name	U.P.\$
VQ0001.02	Replacement Hinge Screw	48.4



Code	Products Name	U.P.\$
VQ0001.03	Replacement Saw Guide Screw	48.4



Code	Products Name	U.P.\$
VQ0001.04	Long Replacement Jig Pin Screw	12.9

# TPLO Surgery Instruments

## Slocum TPLO Jig

Veterinary Use Only



Code	Products Name	Specification	U.P.\$
100323	Slocum TPLO Jig	Small	303.2
100322	Slocum TPLO Jig	Large	303.2

## TPLO Rotary Measuring Device

Veterinary Use Only



Code	Products Name	U.P.\$
M0013	TPLO Rotary Measuring Device	58.1

## TPLO Reduction Forceps

Veterinary Use Only



Code	Products Name	U.P.\$
100331	TPLO Reduction Forceps	206.5

# TPLO SAW

## TPLO Saw

Veterinary Use Only



Code	Products Name	U.P.\$
05.001.204	TPLO Saw	4129

## TPLO Battery

Veterinary Use Only



Code	Products Name	U.P.\$
532.104	TPLO Battery	354.8

## TPLO Battery Charger

Veterinary Use Only



Code	Products Name	U.P.\$
532.010	TPLO Battery Charger	322.6

## TPLO Saw Sterilization Box

Veterinary Use Only



Code	Products Name	U.P.\$
532.026	TPLO Saw Sterilization Box	206.5

## Wrench For Saw Balde Tightening Nut

Veterinary Use Only



Code	Products Name	U.P.\$
532.027	Wrench For Saw Balde Tightening Nut	12.9

## Replacement Jig Pin Screw

Veterinary Use Only



Code	Products Name	U.P.\$
VQ0002.04	Replacement Jig Pin Screw	12.9

## Crescentic Saw Blades

Veterinary Use Only



Code	Products Name	Specification	U.P.\$
03.000.389	Crescentic Saw Blades	6mm Radius	180
03.000.390	Crescentic Saw Blades	8mm Radius	190
03.000.391	Crescentic Saw Blades	10mm Radius	200
03.000.392	Crescentic Saw Blades	12mm Radius	210
03.000.393	Crescentic Saw Blades	15mm Radius	220
03.000.394	Crescentic Saw Blades	18mm Radius	230
03.000.395	Crescentic Saw Blades	21mm Radius	240
03.000.396	Crescentic Saw Blades	24mm Radius	250
03.000.397	Crescentic Saw Blades	27mm Radius	260
03.000.398	Crescentic Saw Blades	30mm Radius	270
03.000.399	Crescentic Saw Blades	33mm Radius	280

## TPLO Saw Blade Adpater

Veterinary Use Only



Code	Products Name	U.P.\$
100332	TPLO Saw Blade Adpater	220

Designed to couple BIORTHO TPLO saw blades to Synthes Colibri Tplo saw.



# TPLO Set



## TPLO Set

Code	Products Name/Specification	Quantity
	TPLO Plates Set	
VQ0002.00	Mini TPLO Jig	1
VQ0002.01	Mini TPLO Jig Straight Legs	1
VQ0001.00	Standard TPLO jig	1
VQ0001.01	Standard TPLO Jig Straight Legs	1
VQ0001.24	Saw Guides 24mm	1
VQ0001.27	Saw Guides 27mm	1
VQ0001.30	Saw Guides 30mm	1
VP4405.L3	2.0mm TPLO Plates L	1
VP4405.R3	2.0mm TPLO Plates R	1
VP4404.L3	2.4mm TPLO Plates L	1
VP4404.R3	2.4mm TPLO Plates R	1
VP4400.L3	2.7mm TPLO Plates L	1
VP4400.R3	2.7mm TPLO Plates R	1
VP4401.L3	3.5mm TPLO Plates L	1
VP4401.R3	3.5mm TPLO Plates R	1
VP4402.L4	3.5mm TPLO Plates L	1
VP4402.R4	3.5mm TPLO Plates R	1
VP4403.L3	3.5mm Small TPLO Plates L	1
VP4403.R3	3.5mm Small TPLO Plates R	1
20.02	TPLO Sterilization Box	1

U.P.\$

4357

# 3.0mm TPLO Set



Code	Products Name	Specification	U.P.\$
TPLO30	3.0mm TPLO Implants Caddy	235X125X52mm	352

## 3.0mm TPLO Set

Code	Products Name/Specification	Quantity
A32QC20	2.0mm AO Style Quick Coupling Drill Bits	1
A32QC24	2.4mm AO Style Quick Coupling Drill Bits	1
A32QC27	2.7mm AO Style Quick Coupling Drill Bits	1
100231	T8 Torx Drive Screwdriver shaft	1
1002310	T10 Torx Drive Screwdriver shaft	1
VP4406.L3	3.0mm TPLO Plates L	2
VP4406.R3	3.0mm TPLO Plates R	2
100181	2.0/2.7mm Double Drill Guide	1
100190	2.0/2.7mm Universal Drill Guide	1
110180	2.4/3.0mm Locking Threaded Drill Guide	2
100336	Three Scales Depth Gauge Range 0-30mm	1
100160	QC Handle 110mm	1
TPLO30	3.0mm TPLO Implants Caddy 235X125X52mm	1
CSTT2708	2.7mm Cortex Self Tapping Screws T8 Torx,L 8mm	3
CSTT2710	2.7mm Cortex Self Tapping Screws T8 Torx,L 10mm	3
CSTT2712	2.7mm Cortex Self Tapping Screws T8 Torx,L 12mm	6
CSTT2714	2.7mm Cortex Self Tapping Screws T8 Torx,L 14mm	6
CSTT2716	2.7mm Cortex Self Tapping Screws T8 Torx,L 16mm	6
CSTT2718	2.7mm Cortex Self Tapping Screws T8 Torx,L 18mm	6
CSTT2720	2.7mm Cortex Self Tapping Screws T8 Torx,L 20mm	6
CSTT2722	2.7mm Cortex Self Tapping Screws T8 Torx,L 22mm	3
CSTT2724	2.7mm Cortex Self Tapping Screws T8 Torx,L 24mm	3
CSTT2726	2.7mm Cortex Self Tapping Screws T8 Torx,L 26mm	3

Code	Products Name/Specification	Quantity
CSTT2728	2.7mm Cortex Self Tapping Screws T8 Torx,L 28mm	3
CSTT2730	2.7mm Cortex Self Tapping Screws T8 Torx,L 30mm	3
CSTT2732	2.7mm Cortex Self Tapping Screws T8 Torx,L 32mm	3
CSTT2734	2.7mm Cortex Self Tapping Screws T8 Torx,L 34mm	3
CSTT2736	2.7mm Cortex Self Tapping Screws T8 Torx,L 36mm	3
CSTT2738	2.7mm Cortex Self Tapping Screws T8 Torx,L 38mm	3
CSTT2740	2.7mm Cortex Self Tapping Screws T8 Torx,L 40mm	3
LS3010	3.0mm Locking Self Tapping Screws, T10 Torx,L 10mm	4
LS3012	3.0mm Locking Self Tapping Screws, T10 Torx,L 12mm	4
LS3014	3.0mm Locking Self Tapping Screws, T10 Torx,L 14mm	4
LS3016	3.0mm Locking Self Tapping Screws, T10 Torx,L 16mm	4
LS3018	3.0mm Locking Self Tapping Screws, T10 Torx,L 18mm	4
LS3020	3.0mm Locking Self Tapping Screws, T10 Torx,L 20mm	8
LS3022	3.0mm Locking Self Tapping Screws, T10 Torx,L 22mm	8
LS3024	3.0mm Locking Self Tapping Screws, T10 Torx,L 24mm	8
LS3026	3.0mm Locking Self Tapping Screws, T10 Torx,L 26mm	8
LS3028	3.0mm Locking Self Tapping Screws, T10 Torx,L 28mm	8
LS3030	3.0mm Locking Self Tapping Screws, T10 Torx,L 30mm	8
LS3032	3.0mm Locking Self Tapping Screws, T10 Torx,L 32mm	4
LS3034	3.0mm Locking Self Tapping Screws, T10 Torx,L 34mm	4
LS3036	3.0mm Locking Self Tapping Screws, T10 Torx,L 36mm	4
LS3038	3.0mm Locking Self Tapping Screws, T10 Torx,L 38mm	4
LS3040	3.0mm Locking Self Tapping Screws, T10 Torx,L 40mm	4

U.P.\$	3302
--------	------

**TPLO Rotation.** Quick Reference Chart.



Rotation Calculation Intended to Leave 5 degrees

TPA Angle	TPLO Blade Size (mm)									
	8	10	12	15	18	21	24	27	30	33
10	0.70	0.87	1.05	1.31	1.57	1.83	2.09	2.36	2.62	2.88
11	0.84	1.05	1.26	1.57	1.88	2.20	2.51	2.83	3.14	3.46
12	0.98	1.22	1.47	1.83	2.20	2.57	2.93	3.30	3.67	4.03
13	1.12	1.40	1.68	2.09	2.51	2.93	3.35	3.77	4.19	4.61
14	1.26	1.57	1.88	2.36	2.83	3.30	3.77	4.24	4.71	5.18
15	1.40	1.75	2.09	2.62	3.14	3.67	4.19	4.71	5.24	5.76
16	1.54	1.92	2.30	2.88	3.46	4.03	4.61	5.18	5.76	6.34
17	1.68	2.09	2.51	3.14	3.77	4.40	5.03	5.65	6.28	6.91
18	1.82	2.27	2.72	3.40	4.08	4.76	5.45	6.13	6.81	7.49
19	1.95	2.44	2.93	3.67	4.40	5.13	5.86	6.60	7.33	8.06
20	2.09	2.62	3.14	3.93	4.71	5.50	6.28	7.07	7.85	8.64
21	2.23	2.79	3.35	4.19	5.03	5.86	6.70	7.54	8.38	9.22
22	2.37	2.97	3.56	4.45	5.34	6.23	7.12	8.01	8.90	9.79
23	2.51	3.14	3.77	4.71	5.65	6.60	7.54	8.48	9.42	10.37
24	2.65	3.32	3.98	4.97	5.97	6.96	7.96	8.95	9.95	10.94
25	2.79	3.49	4.19	5.24	6.28	7.33	8.38	9.42	10.47	11.52
26	2.93	3.67	4.40	5.50	6.60	7.70	8.80	9.90	11.00	12.10
27	3.07	3.84	4.61	5.76	6.91	8.06	9.22	10.37	11.52	12.67
28	3.21	4.01	4.82	6.02	7.23	8.43	9.63	10.84	12.04	13.25
29	3.35	4.19	5.03	6.28	7.54	8.80	10.05	11.31	12.57	13.82
30	3.49	4.36	5.24	6.54	7.85	9.16	10.47	11.78	13.09	14.40
31	3.63	4.54	5.45	6.81	8.17	9.53	10.89	12.25	13.61	14.97
32	3.77	4.71	5.65	7.07	8.48	9.90	11.31	12.72	14.14	15.55
33	3.91	4.89	5.86	7.33	8.80	10.26	11.73	13.19	14.66	16.13
34	4.05	5.06	6.07	7.59	9.11	10.63	12.15	13.67	15.18	16.70
35	4.19	5.24	6.28	7.85	9.42	11.00	12.57	14.14	15.71	17.28
36	4.33	5.41	6.49	8.12	9.74	11.36	12.99	14.61	16.23	17.85
37	4.47	5.59	6.70	8.38	10.05	11.73	13.40	15.08	16.76	18.43
38	4.61	5.76	6.91	8.64	10.37	12.10	13.82	15.55	17.28	19.01
39	4.75	5.93	7.12	8.90	10.68	12.46	14.24	16.02	17.80	19.58
40	4.89	6.11	7.33	9.16	11.00	12.83	14.66	16.49	18.33	20.16
41	5.03	6.28	7.54	9.42	11.31	13.19	15.08	16.96	18.85	20.73
42	5.17	6.46	7.75	9.69	11.62	13.56	15.50	17.44	19.37	21.31
43	5.31	6.63	7.96	9.95	11.94	13.93	15.92	17.91	19.90	21.89
44	5.45	6.81	8.17	10.21	12.25	14.29	16.34	18.38	20.42	22.46
45	5.59	6.98	8.38	10.47	12.57	14.66	16.76	18.85	20.94	23.04



# Pin And Wire

## Cerclage Wire

Veterinary Use Only Stainless Steel 316LVM

Unit mm,m



Code	Products Name	Dia(mm)	L(m)	U.P.\$
OW0310	Cerclage Wire	0.3	10	16.1
OW0510	Cerclage Wire	0.5	10	14.5
OW0810	Cerclage Wire	0.8	10	12.9
OW1010	Cerclage Wire	1.0	10	12.9
OW1210	Cerclage Wire	1.2	10	12.9



## Wire Passers

Veterinary Use Only

Unit mm



Code	Products Name	Dia	Hole Diameter	U.P.\$
100046	Wire Passers	13.8	0.5	41.9
100047	Wire Passers	20	0.8	38.7
100048	Wire Passers	30	1.2	38.7
100049	Wire Passers	40	1.5	38.7



## Wire Tightener With Two Cranks

Veterinary Use Only

Unit mm



Code	Products Name	L	U.P.\$
100050	Wire Tightener With Two Cranks	260	138.7



## Cerclage Wire Twisters/Tighteners/Cutter

Veterinary Use Only



Unit mm

Code	Products Name	L	U.P.\$
100051	Cerclage Wire Twisters/Tighteners/Cutter	150	109.7

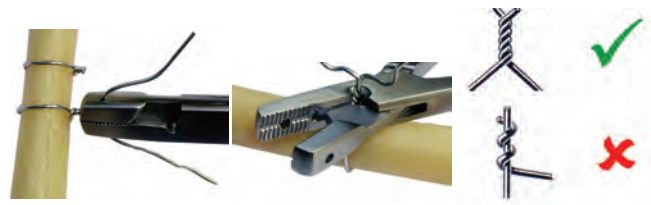

## K' Wire Pin Punch

Veterinary Use Only



Unit mm

Code	Products Name	Range	L	U.P.\$
100052	K' Wire/Small Pin Punch	1.5-2.5	135	35.5
100053	Very Small Pin Punch	0.6-1.6	135	35.5

## K' Wire Bender

Veterinary Use Only



Unit mm

Code	Products Name	Range	L	U.P.\$
100054	K' Wire Bender	0.6-2.5	140	51.6



Kirschner Wire (Medical stainless steel 316L)

Veterinary Use Only

Stainless Steel 316LVM

Unit mm

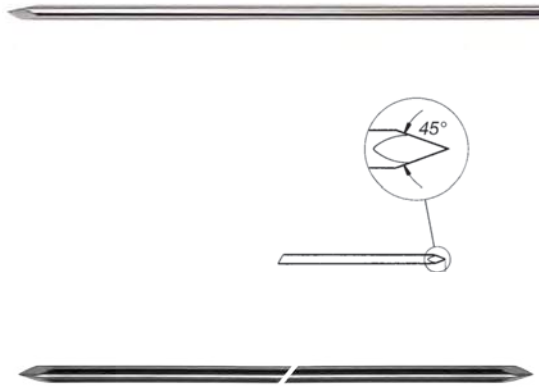

Code	Products Name	Dia	U.P.\$
PS0825	Kirschner Wire Single Head Sharp	0.8	1.1
PS1025	Kirschner Wire Single Head Sharp	1.0	1.1
PS1225	Kirschner Wire Single Head Sharp	1.2	1.3
PS1525	Kirschner Wire Single Head Sharp	1.5	1.3
PS1625	Kirschner Wire Single Head Sharp	1.6	1.6
PS1825	Kirschner Wire Single Head Sharp	1.8	1.6
PS2025	Kirschner Wire Single Head Sharp	2.0	1.6
PS2525	Kirschner Wire Single Head Sharp	2.5	1.6
PS3025	Kirschner Wire Single Head Sharp	3.0	1.9
PS3525	Kirschner Wire Single Head Sharp	3.5	2.3
PS4025	Kirschner Wire Single Head Sharp	4.0	2.9

Code	Products Name	Dia	U.P.\$
PS0825D	Kirschner Wire Double Head Sharp	0.8	1.6
PS1025D	Kirschner Wire Double Head Sharp	1.0	1.6
PS1225D	Kirschner Wire Double Head Sharp	1.2	2.4
PS1525D	Kirschner Wire Double Head Sharp	1.5	2.4
PS2025D	Kirschner Wire Double Head Sharp	2.0	2.9
PS2525D	Kirschner Wire Double Head Sharp	2.5	2.9
PS3025D	Kirschner Wire Double Head Sharp	3.0	2.9

Kirschner Wire (Titanium)

Veterinary Use Only

Titanium Grade 5

Unit mm



Code	Products Name	Dia	U.P.\$
PT08	Kirschner Wire(Titanium)	0.8	3.5
PT10	Kirschner Wire(Titanium)	1.0	4.2
PT12	Kirschner Wire(Titanium)	1.2	4.8
PT15	Kirschner Wire(Titanium)	1.5	5.8
PT20	Kirschner Wire(Titanium)	2.0	6.5
PT25	Kirschner Wire(Titanium)	2.5	7.3
PT30	Kirschner Wire(Titanium)	3.0	8.1
PT35	Kirschner Wire(Titanium)	3.5	8.9

Kirschner Wire Racks

Veterinary Use Only

Unit mm



Code	Products Name	Specification	U.P.\$
PB0001	K Wire Racks	330X140X50mm	193.5

K wires/Drill Bits Tube

Veterinary Use Only



Unit mm

Code	Products Name	L	U.P.\$
PT250	large K wires Tube	250	58.1
PT150	Small Drill Bits Tube	150	51.6

# Pin and Wire Instrument Set



## Pin and Wire Instrument Set

Code	Products Name/Specification	Quantity
000010	Pin and Wire Instrument Set	
100050	Wire Tightener With Two Cranks	1
100051	Cerclage Wire Twisters/Tighteners/Cutter	1
100054	K' Wire Bender	1
100048	Wire Passers large	1
100047	Wire Passers small	1
100035	Small Pin Plier	1
100030	Safety Pin Cutting Forceps	1
100040	Plate/ Pin Cutting Plier TC Gold to 2.2mm capacity	1
100039	Plate/ Pin Cutting Plier TC Gold to 2.8mm capacity	1
100041	Front End Wire Cutting Plier TC Gold to 2.8mm capacity	1
100036	Parallel Action Plier	1
000010E	Pin and Wire Instrument Set customization Sterilization Box	1

U.P.\$ 2096.8

# Small Animals Interlocking Nail I-LOCK Set

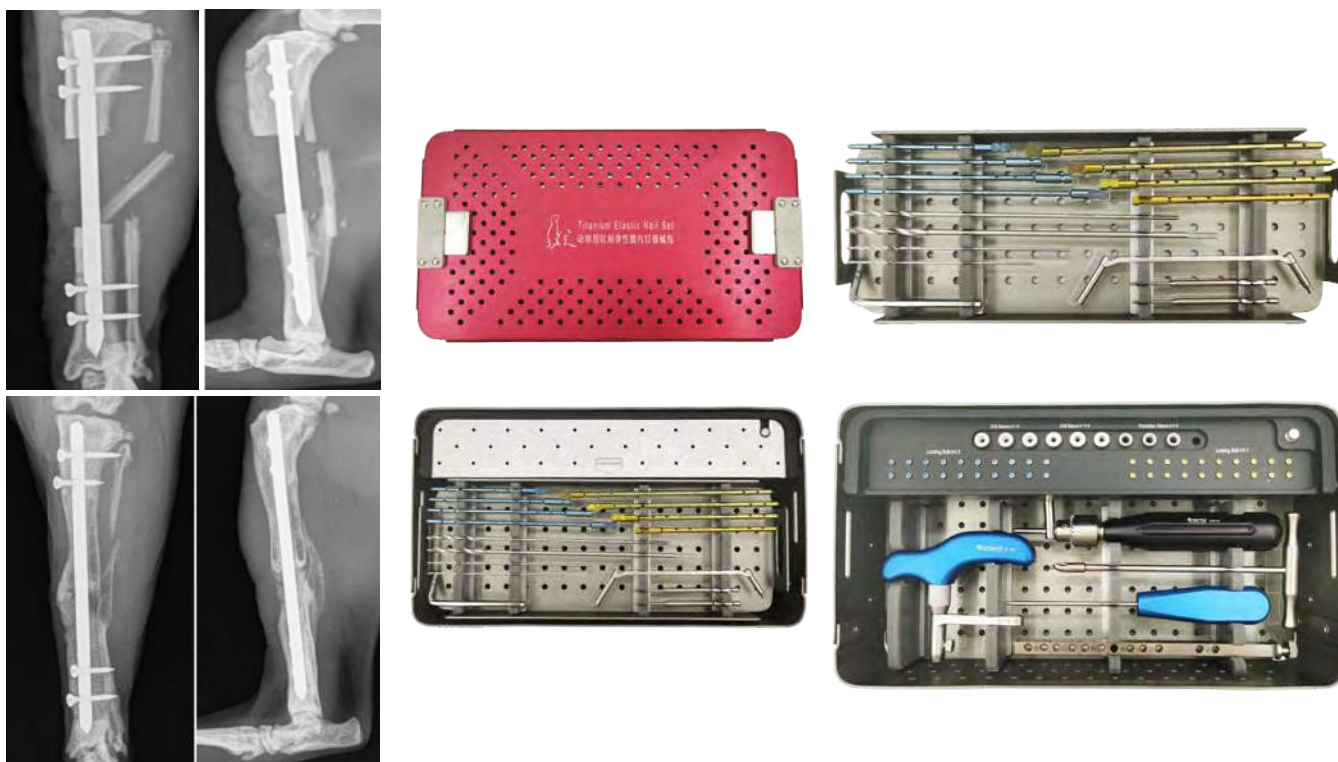

## Small Animals Interlocking Nail I-LOCK Set

Code	Products Name/Specification	Quantity
	Small Animals Interlocking Nail I-LOCK Set	
22.001	Aiming Device For Interlocking Nail	1
22.002	Guiding Rod For Aiming Device	1
22.003	Screwdriver For Locking Bolt T6	1
22.004	Reamer For Proximal End	1
100042	Small Jacobs Chuck With Straight Handle 0-4mm	1
22.006	Sleeve For Temporary Position Pin	4
22.007	Protection Sleeve For Intramedullary Reaming	1
22.008	Protection Sleeve For Locking Bolt Inserting $\Phi$ 3.5mm	4
22.009	Drill Sleeve For Locking Bolt $\Phi$ 1.5/3.5mm	2
22.010	Drill Sleeve For Locking Bolt $\Phi$ 2.0/3.5mm	2
22.011	Allen Key SW4.0	1
22.012	Intramedullary Reamer $\Phi$ 3.0mm	1
22.013	Intramedullary Reamer $\Phi$ 4.0mm	1
A32A15	Drill Bits 1.5mm	1
A32A20	Drill Bits 2.0mm	1
22.016	Screw Rack For Locking Bolt	1
22.017	Sterilization Box For Interlocking Nail System	1
22.018	$\Phi$ 3.0mm Interlocking Nail,Length 68mm	1
22.019	$\Phi$ 3.0mm Interlocking Nail,Length 86mm	1
22.020	$\Phi$ 3.0mm Interlocking Nail,Length 104mm	1
22.021	$\Phi$ 3.0mm Interlocking Nail,Length 122mm	1
22.022	$\Phi$ 4.0mm Interlocking Nail,Length 86mm	1
22.023	$\Phi$ 4.0mm Interlocking Nail,Length 104mm	1
22.024	$\Phi$ 4.0mm Interlocking Nail,Length 122mm	1
22.025	$\Phi$ 4.0mm Interlocking Nail,Length 140mm	1
22.026	Locking Bolt $\Phi$ 1.5/2.0mm	6
22.027	Locking Bolt $\Phi$ 2.0/2.7mm	6

# Interlocking Nail I-LOCK System

## Protection Sleeve For Locking Bolt Inserting

Veterinary Use Only



Unit mm

Code	Products Name	Dia	U.P.\$
22.008	Protection Sleeve For Locking Bolt Inserting	Φ3.5	167.7

## Drill Sleeve For Locking Bolt

Veterinary Use Only



Unit mm

Code	Products Name	Dia	U.P.\$
22.009	Drill Sleeve For Locking Bolt	Φ1.5/3.5	83.9
22.010	Drill Sleeve For Locking Bolt	Φ2.0/3.5	83.9

## Interlocking Nail

Veterinary Use Only

Titanium Grade 5



Unit mm

Code	Products Name	Dia	L	U.P.\$
22.018	Interlocking Nail	Φ3.0	68	67.7
22.019	Interlocking Nail	Φ3.0	86	77.4
22.020	Interlocking Nail	Φ3.0	104	87.1
22.021	Interlocking Nail	Φ3.0	122	95.2

## Locking Bolt

Veterinary Use Only

Titanium Grade 5



Unit mm

Code	Products Name	Dia	U.P.\$
22.026	Locking Bolt	Φ1.5/2.0	12.6

## Interlocking Nail

Veterinary Use Only

Titanium Grade 5



Unit mm

Code	Products Name	Dia	L	U.P.\$
22.022	Interlocking Nail	Φ4.0	86	77.4
22.023	Interlocking Nail	Φ4.0	104	87.1
22.024	Interlocking Nail	Φ4.0	122	95.2
22.025	Interlocking Nail	Φ4.0	140	104.8

## Locking Bolt

Veterinary Use Only

Titanium Grade 5



Unit mm

Code	Products Name	Dia	U.P.\$
22.027	Locking Bolt	Φ2.0/2.7	12.6

# Mini External Fixation System

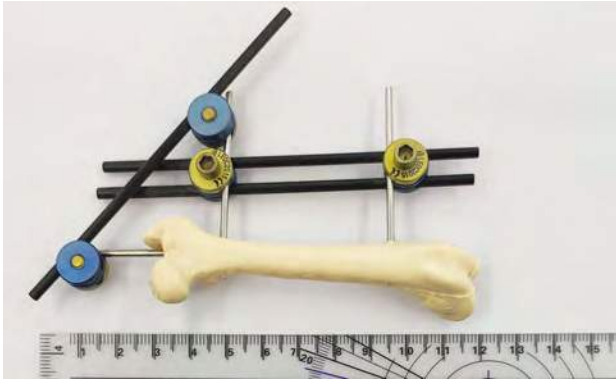

## Carbon Fiber Rod

Veterinary Use Only

Unit mm

Code	Products Name	Dia	L	U.P.\$
ROD0360C	Carbon Fiber Rod	3.0mm	60mm	11
ROD0380C	Carbon Fiber Rod	3.0mm	80mm	11
ROD03100C	Carbon Fiber Rod	3.0mm	100mm	11



## Titanium Middle Positive Thread Pin

Veterinary Use Only Titanium Grade 5

Unit mm

Code	Products Name	Thread Dia	Shaft Dia	L	U.P.\$
TA2015080M	Titanium Middle Positive Thread Pin	2.0mm	1.5mm	80mm	20.6
TA2024100M	Titanium Middle Positive Thread Pin	2.4mm	2.0mm	100mm	20.6



## Titanium End Positive Thread Pin

Veterinary Use Only Titanium Grade 5

Unit mm

Code	Products Name	Thread Dia	Shaft Dia	L	U.P.\$
TA1215080E	Titanium End Positive Thread Pin	1.5mm	1.2mm	80mm	15.8
TA1620080E	Titanium End Positive Thread Pin	2.0mm	1.6mm	80mm	15.8
TA2024100E	Titanium End Positive Thread Pin	2.4mm	2.0mm	100mm	15.8
TA2432100E	Titanium End Positive Thread Pin	3.2mm	2.4mm	100mm	15.8



## Titanium Rod Clamp

Veterinary Use Only Titanium Grade 5

Unit mm,g

Code	Products Name	Needle Dia	Specification	U.P.\$
EF1015T	Titanium Rod Clamp	1.0-1.5mm	4g	35.5



## Titanium Rod Clamp

Veterinary Use Only Titanium Grade 5

Unit mm,g

Code	Products Name	Needle Dia	Specification	U.P.\$
EF1520T	Titanium Rod Clamp	1.5-2.0mm	4g	35.5



# Mini External Fixation System



## Mini External Fixation System

Code	Products Name/Specification	Quantity
EF1015T	Titanium Rod Clamp 1.0/1.5mm	8
EF1520T	Titanium Rod Clamp 1.5/2.0mm	8
ROD0360C	Carbon Fiber Rod, 3X60mm	2
ROD0380C	Carbon Fiber Rod, 3X80mm	2
ROD03100C	Carbon Fiber Rod, 3X100mm	2
TA2015080M	Titanium Middle Positive Thread Pin	4
TA1620080E	Titanium Bottom Positive Thread Pin	8
EF0001	Rod Clamp Match Allen Key	1

U.P.\$ 855.7



# ESF External Fixation

## SK Rod Clamp

Veterinary Use Only



Unit mm

Code	Products Name	Specification	U.P.\$
400001	SK Pin Rod Clamp	Mini	35.5
400002	SK Pin Rod Clamp	Medium	35.5
400003	SK Pin Rod Clamp	Large	35.5

## SK Rod Rod Clamp

Veterinary Use Only



Code	Products Name	Specification	U.P.\$
400011	SK Rod Rod Clamp	Mini	41.9
400012	SK Rod Rod Clamp	Medium	41.9
400013	SK Rod Rod Clamp	Large	41.9

## SK Carbon Fiber Rod

Veterinary Use Only

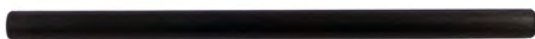

Unit mm

Code	Products Name	Specification	U.P.\$
435050	SK Carbon Fiber Rod	Small 3.5mmX50mm	11
435075	SK Carbon Fiber Rod	Small 3.5mmX75mm	11
435100	SK Carbon Fiber Rod	Small 3.5mmX100mm	12.6
435125	SK Carbon Fiber Rod	Small 3.5mmX125mm	12.6
435150	SK Carbon Fiber Rod	Small 3.5mmX150mm	14.2
463050	SK Carbon Fiber Rod	Medium 6.3X50mm	12.6
463100	SK Carbon Fiber Rod	Medium 6.3X100mm	14.2
463150	SK Carbon Fiber Rod	Medium 6.3X150mm	14.2
463200	SK Carbon Fiber Rod	Medium 6.3X200mm	15.8
463250	SK Carbon Fiber Rod	Medium 6.3X250mm	15.8
495050	SK Carbon Fiber Rod	Large 9.5X50mm	14.2
495100	SK Carbon Fiber Rod	Large 9.5X100mm	14.2
495150	SK Carbon Fiber Rod	Large 9.5X150mm	15.8
495200	SK Carbon Fiber Rod	Large 9.5X200mm	15.8
495250	SK Carbon Fiber Rod	Large 9.5X250mm	19
495300	SK Carbon Fiber Rod	Large 9.5X300mm	19

## Sleeve Wrench

Veterinary Use Only



Unit mm

Code	Products Name	Specification	U.P.\$
400100	Sleeve Wrench	Small 7mm	16.1
400103	Sleeve Wrench	Medium 8mm	16.1
400106	Sleeve Wrench	Large 10mm	16.1

## Double End Wrench

Veterinary Use Only



Unit mm

Code	Products Name	Specification	U.P.\$
400101	Double End Wrench	Small 7mm	12.9
400104	Double End Wrench	Medium 8mm	12.9
400107	Double End Wrench	Large 10mm	12.9

## ESF Drill Sleeve

Veterinary Use Only



Code	Products Name	Specification	U.P.\$
400201	ESF Drill Sleeve	Small	67.7
400202	ESF Drill Sleeve	Medium	67.7
400203	ESF Drill Sleeve	Large	67.7

## End Thread Pin

Veterinary Use Only Stainless Steel 316LVM

Unit mm



Code	Products Name	Shaft/Thread Dia	Pilot hole drill Dia	U.P.\$
SS4010	End Thread Pin	1.0/1.0	0.8	4.5
SS4015	End Thread Pin	1.5/1.5	1.1	4.5
SS4018	End Thread Pin	1.8/1.8	1.3	5.6
SS4020	End Thread Pin	2.0/2.0	1.5	4.5
SS4025	End Thread Pin	2.5/2.5	2.0	4.8
SS4030	End Thread Pin	3.0/3.0	2.4	4.8
SS4035	End Thread Pin	3.5/3.5	2.7	4.8
SS4040	End Thread Pin	4.0/4.0	3.0	4.8

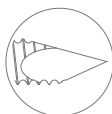

Trocar

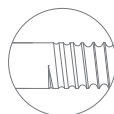

Normal Thread

# End Thread Pin

End Positive Thread Pin

Veterinary Use Only

Stainless Steel 316LVM

Unit mm

Code	Products Name	Shaft/Thread Dia	Pilot hole drin Dia	Thread L	L	U.P.\$
400912E	End Positive Thread Pin	0.9/1.2	0.8	12	65	14.2
401115E	End Positive Thread Pin	1.1/1.5	1.1	12	70	14.2
401418E	End Positive Thread Pin	1.4/1.8	1.3	15	80	14.2
401822E	End Positive Thread Pin	1.8/2.2	1.8	15	85	14.2
402024E	End Positive Thread Pin	2.0/2.4	2.0	17	90	14.2
402432E	End Positive Thread Pin	2.4/3.2	2.4	25	105	14.2
402835E	End Positive Thread Pin	2.8/3.5	2.7	35	150	14.2
403240E	End Positive Thread Pin	3.2/4.0	3.2	32	150	14.2
403543E	End Positive Thread Pin	3.5/4.3	3.5	45	160	14.2



Trocar

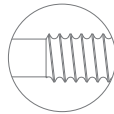

Positive Thread

Middle Positive Thread Pin

Veterinary Use Only

Stainless Steel 316LVM

Unit mm

Code	Products Name	Shaft/Thread Dia	Pilot hole drin Dia	Thread L	L	U.P.\$
400912M	Middle Positive Thread Pin	0.9/1.2	0.8	12	65	17.4
401115M	Middle Positive Thread Pin	1.1/1.5	1.1	12	70	17.4
401418M	Middle Positive Thread Pin	1.4/1.8	1.3	15	80	17.4
401822M	Middle Positive Thread Pin	1.8/2.2	1.8	15	85	17.4
402024M	Middle Positive Thread Pin	2.0/2.4	2.0	17	90	17.4
402432M	Middle Positive Thread Pin	2.4/3.2	2.4	25	105	20.6
402835M	Middle Positive Thread Pin	2.8/3.5	2.7	38	160	20.6
403240M	Middle Positive Thread Pin	3.2/4.0	3.2	32	160	20.6
403543M	Middle Positive Thread Pin	3.5/4.3	3.5	40	180	20.6



Trocar

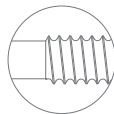

Positive Thread

# SK External Fixation System

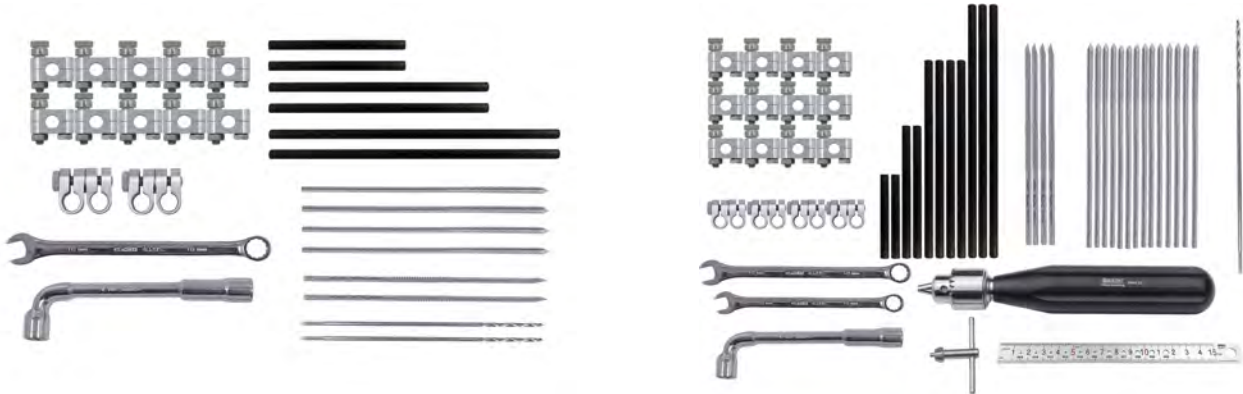

## Mini ESF SK Starter Set

### Mini ESF SK Starter Set

Code	Products Name/Specification	Quantity
410001	Small ESF SK Starter Set	
400001	Small Pin Rod Clamp	10
400011	Small Rod Rod Clamp	2
435075	3.5mmX75mm Carbon Fiber Rod	2
435100	3.5mmX100mm Carbon Fiber Rod	2
435125	3.5mmX125mm Carbon Fiber Rod	2
400100	7mm Sleeve Wrench	1
400101	7mm Double End Wrench	1
Specification Optional	Drill Bits	2
Specification Optional	End Positive Thread Pin	4
Specification Optional	Middle Positive Thread Pin	2
<b>U.P.\$</b>		641.9

### Mini ESF SK Complete Set

Code	Products Name/Specification	Quantity
410011	Small ESF SK Complete Set	
400001	Small Pin Rod Clamp	12
400011	Small Rod Rod Clamp	4
435050	3.5mmX50mm Carbon Fiber Rod	2
435075	3.5mmX75mm Carbon Fiber Rod	2
435100	3.5mmX100mm Carbon Fiber Rod	4
435125	3.5mmX125mm Carbon Fiber Rod	2
400100	7mm Sleeve Wrench	2
400101	7mm Double End Wrench	1
Specification Optional	Drill Bits	2
Specification Optional	End Positive Thread Pin	12
Specification Optional	Middle Positive Thread Pin	4
100042	Small Jacobs Chuck With Straight Handle	1
M0009	Stainless Steel Measuring Ruler	1
<b>U.P.\$</b>		1162.3

## Medium ESF SK Starter Set

### Medium ESF SK Starter Set

Code	Products Name/Specification	Quantity
410002	Medium ESF SK Starter Set	
400002	Medium Pin Rod Clamp	10
400012	Medium Rod Rod Clamp	2
463100	6.3mmX100mm Carbon Fiber Rod	2
463150	6.3mmX150mm Carbon Fiber Rod	2
463200	6.3mmX200mm Carbon Fiber Rod	2
400103	8mm Sleeve Wrench	1
400104	8mm Double End Wrench	1
Specification Optional	Drill Bits	2
Specification Optional	End Positive Thread Pin	4
Specification Optional	Middle Positive Thread Pin	2
<b>U.P.\$</b>		641.9

### Medium ESF SK Complete Set

Code	Products Name/Specification	Quantity
410012	Medium ESF SK Complete Set	
400002	Medium Pin Rod Clamp	12
400012	Medium Rod Rod Clamp	4
463050	6.3mmX50mm Carbon Fiber Rod	2
463100	6.3mmX100mm Carbon Fiber Rod	2
463150	6.3mmX150mm Carbon Fiber Rod	4
463200	6.3mmX200mm Carbon Fiber Rod	2
400103	8mm Sleeve Wrench	2
400104	8mm Double End Wrench	1
Specification Optional	Drill Bits	2
Specification Optional	End Positive Thread Pin	12
Specification Optional	Middle Positive Thread Pin	4
100042	Small Jacobs Chuck With Straight Handle	1
M0009	Stainless Steel Measuring Ruler	1
<b>U.P.\$</b>		1184.8

# SK External Fixation System

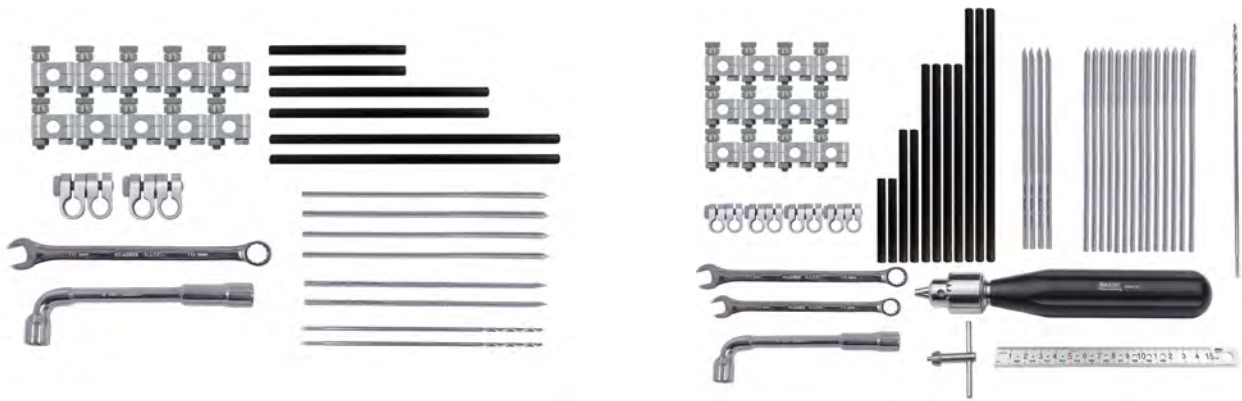

## SK Large Set

### Large ESF SK Starter Set

Code	Products Name/Specification	Quantity
410003	Large ESF SK Starter Set	
400003	Large Pin Rod Clamp	10
400013	Large Rod Rod Clamp	2
495150	9.5mmX100mm Carbon Fiber Rod	2
495200	9.5mmX150mm Carbon Fiber Rod	2
495250	9.5mmX200mm Carbon Fiber Rod	2
400106	10mm Sleeve Wrench	1
400107	10mm Double End Wrench	1
Specification Optional	Drill Bits	2
Specification Optional	End Positive Thread Pin	4
Specification Optional	Middle Positive Thread Pin	2
<b>U.P.\$</b>		<b>641.9</b>

### Large ESF SK Complete Set

Code	Products Name/Specification	Quantity
410013	Large ESF SK Complete Set	
400003	Large Pin Rod Clamp	12
400013	Large Rod Rod Clamp	4
495050	9.5mmX50mm Carbon Fiber Rod	2
495100	9.5mmX100mm Carbon Fiber Rod	2
495150	9.5mmX150mm Carbon Fiber Rod	4
495200	9.5mmX200mm Carbon Fiber Rod	2
400106	10mm Sleeve Wrench	2
400107	10mm Double End Wrench	1
Specification Optional	Drill Bits	2
Specification Optional	End Positive Thread Pin	12
Specification Optional	Middle Positive Thread Pin	4
100042	Small Jacobs Chuck With Straight Handle	1
M0009	Stainless Steel Measuring Ruler	1

**U.P.\$**      **1194.5**

# SK External Fixation System

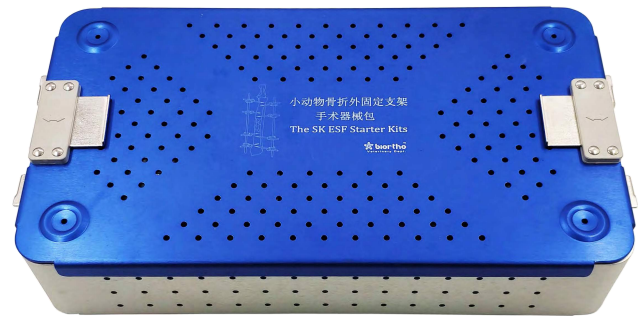

## SK External Fixation System Complete Set

Code	Products Name/Speciliaation	Quantity
410000	SK® External Fixation System Complete Set	
400001	Small Pin Rod Clamp	10
400011	Small Rod Rod Clamp	2
435075	3.5mmX75mm Carbon Fiber Rod	2
435100	3.5mmX100mm Carbon Fiber Rod	2
435125	3.5mmX125mm Carbon Fiber Rod	2
400100	7mm Double End Wrench	1
400101	7mm Sleeve Wrench	1
Specification Optional	Drill Bits	2
Specification Optional	End Positive Thread Pin	4
Specification Optional	Middle Positive Thread Pin	2
400002	Medium Pin Rod Clamp	10
400012	Medium Rod Rod Clamp	2
463100	6.3mmX100mm Carbon Fiber Rod	2
463150	6.3mmX150mm Carbon Fiber Rod	2
463200	6.3mmX200mm Carbon Fiber Rod	2
400103	8mm Double End Wrench	1
400104	8mm Sleeve Wrench	1
Specification Optional	Drill Bits	2
Specification Optional	End Positive Thread Pin	4
Specification Optional	Middle Positive Thread Pin	2
400003	Large Pin Rod Clamp	10
400013	Large Rod Rod Clamp	2
495150	9.5mmX100mm Carbon Fiber Rod	2
495200	9.5mmX150mm Carbon Fiber Rod	2
495250	9.5mmX200mm Carbon Fiber Rod	2
400106	10mm Double End Wrench	1
400107	10mm Sleeve Wrench	1
Specification Optional	Drill Bits	2
Specification Optional	End Positive Thread Pin	4
Specification Optional	Middle Positive Thread Pin	2
410000E	Sterilization Case	1

U.P.\$

2196.8

# AO Style Titanium Elastic nail Instruments Set A

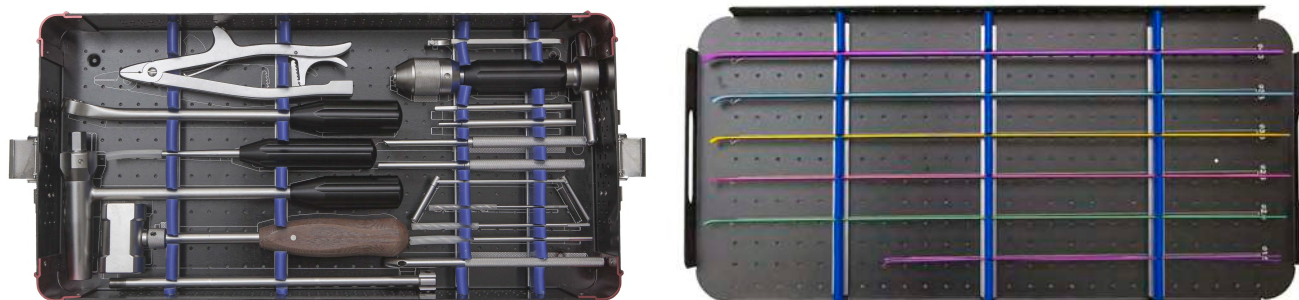

## AO Style Titanium Elastic nail Instruments Set A

Code	Products Name/Specilaation	Quantity
000010	Elastic nail Instruments Set	
A32A27	Drill Bits 2.7X115mm	1
A32A32	Drill Bits 3.2X150mm	1
A32A45	Drill Bits 4.5X135mm	1
100183	Combination Drill 3.2/4.5	1
	Bender, for Titanium Elastic Nails	2
	Cap Socket Wrench Small	1
	Cap Socket Wrench Large	1
	Wire Pin Punch Flat	1
	Wire Pin Punch Oblique	1
	Pull Out Pliers	1
	Screw Breakage Implement 2.5/3.2/4.0mm	1
	Self Locking Drill Chuck	1
	Sliding Guide Bar With A Hammer M10	1
	Sliding Hammer With Movable Head 400g	1
	Self Locking Drill Chuck Wrench	1
	Open Mouth Implement Straight	1
	Titanium Nickel Alloy Elastic Intramedullary Nail 1.5X300mm	2
	Titanium Nickel Alloy Elastic Intramedullary Nail 2.0X440mm	2
	Titanium Nickel Alloy Elastic Intramedullary Nail 2.5X440mm	2
	Titanium Nickel Alloy Elastic Intramedullary Nail 3.0X440mm	2
	Titanium Nickel Alloy Elastic Intramedullary Nail 3.5X440mm	2
	Titanium Nickel Alloy Elastic Intramedullary Nail 4.0X440mm	2
	Elastic nail Instruments Set A Instruments Box	1

U.P.\$ 2225.8

### Open Awl

Veterinary Use Only

Unit mm



Code	Products Name	L	U.P.\$
ASEN002	Open Awl	180	61.3

# AO Style Small Animal Rush Pin Instruments Set

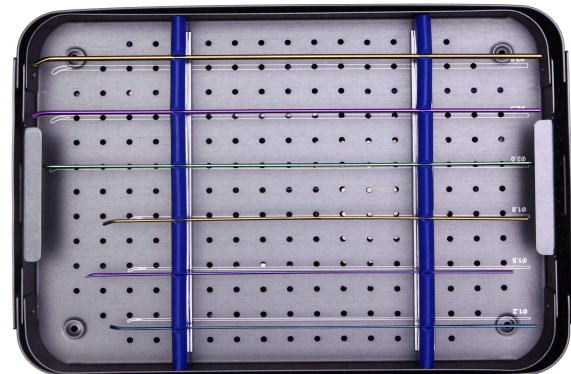
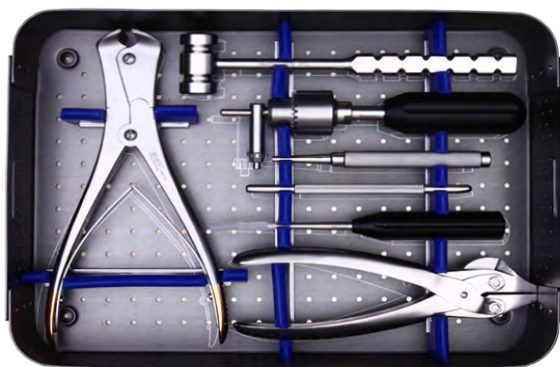

## AO Style Small Animal Rush Pin Instruments Set

Code	Products Name/Speciliaation	Quantity
ASEN000	AO Small Animal Rush Pin Instruments Set	
100036	Parallel Action Pliers	1
ASEN002	Open Awl	1
100054	K' Wire Bender	1
100052	'K'Wire/SmallPin Punch	1
100042	Small Jacobs Chuck With Straight Handle	1
100060	Orthopedic Mallet	1
100041	Front End Wire Cutting Plier TC Gold to2.8mm capacity	1
110012	AO ELASTIC NAIL 1.2mm	2
110015	AO ELASTIC NAIL 1.5mm	2
110018	AO ELASTIC NAIL 8mm	2
110020	AO ELASTIC NAIL 2.0mm	2
110025	AO ELASTIC NAIL 2.5mm	2
110030	AO ELASTIC NAIL 3.0mm	2
ASEN0B	AO Style Small Animal Rush Pin Instruments Box	1

U.P.\$ 1421.8

## Elastic Nail

Veterinary Use Only Titanium Grade 5



Unit mm

Code	Products Name	Speciliaation	U.P.\$
110012	Elastic Nail	1.2	30.3
110015	Elastic Nail	1.5	30.3
110020	Elastic Nail	2.0	30.3
110025	Elastic Nail	2.5	30.3
110030	Elastic Nail	3.0	30.3
110035	Elastic Nail	3.5	30.3
110040	Elastic Nail	4.0	30.3

## Elastic Nail Cap

Veterinary Use Only Titanium Grade 5



Unit mm

Code	Products Name	Speciliaation	U.P.\$
110001	Elastic Nail Cap	Small	27.1
110002	Elastic Nail Cap	Large	27.1



# HCS Headless Compression Screw Instruments Set

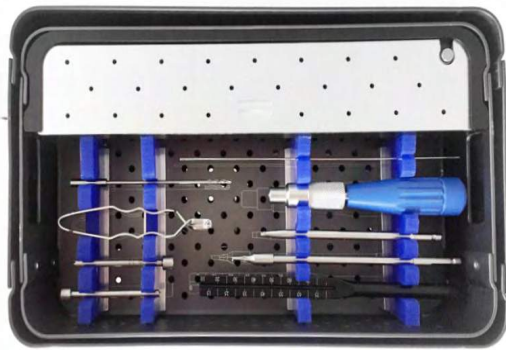

## HCS Headless Compression Screw Instruments Set

Code	Products Name/Speciliaation	Quantity
HCS0001	HCS Compression Screw Instruments Set	
301007	Large Aiming Forceps	1
301107	Large Aiming Device	1
301104	Φ1.8mm Drill Sleeve	1
301105	Φ2.0mm Drill Sleeve	1
301108	Φ2.5mm Drill Sleeve	1
HCS0002	2.4/3.0 HCS Compression Screwdriver	1
HCS0003	3.0/4.0 HCS Compression Screwdriver	1
A32CAN20	Φ2.0 Cannulated Screw Jacob QC	1
HCS004	HCS Cannulated Countersink AO QC	1
100160	AO Straight Handle QC	1
HCS005	Cannulated Screw Measuring Device	1
SS4010	1.0mm Guide Wire	2
100227	SW 2.0 Screwdriver Hexagonal AO QC	1
100233	Screw Holding Forceps	1
	2.4mm HCS Titanium Compression Screw	
HCS243012	12mm L	4
HCS243014	14mm L	4
HCS243016	16mm L	4
HCS243018	18mm L	4
HCS243020	20mm L	4
HCS243022	22mm L	4

Code	Products Name/Speciliaation	Quantity
HCS243024	24mm L	4
HCS243026	26mm L	4
HCS243028	28mm L	4
HCS243030	30mm L	4
	3.0mm HCS Titanium Compression Screw	
HCS304012	12mm L	4
HCS304014	14mm L	4
HCS304016	16mm L	4
HCS304018	18mm L	4
HCS304020	20mm L	4
HCS304022	22mm L	4
HCS304024	24mm L	4
HCS304026	26mm L	4
HCS304028	28mm L	4
HCS304030	30mm L	4
HCS304032	32mm L	4
HCS304034	34mm L	4
HCS304036	36mm L	4
HCS304038	38mm L	4
HCS304040	40mm L	4

U.P.\$ 5905.8

# Titanium Headless Compression Screw

2.4/3.0 HCS Titanium Compression Screw **Veterinary Use Only** Titanium Grade 5

Unit mm



Code	Products Name	L	U.P.\$
HCS243012	2.4/3.0 HCS Titanium Compression Screw	12	36.8
HCS243014	2.4/3.0 HCS Titanium Compression Screw	14	36.8
HCS243016	2.4/3.0 HCS Titanium Compression Screw	16	36.8
HCS243018	2.4/3.0 HCS Titanium Compression Screw	18	36.8
HCS243020	2.4/3.0 HCS Titanium Compression Screw	20	36.8
HCS243022	2.4/3.0 HCS Titanium Compression Screw	22	36.8
HCS243024	2.4/3.0 HCS Titanium Compression Screw	24	36.8
HCS243026	2.4/3.0 HCS Titanium Compression Screw	26	36.8
HCS243028	2.4/3.0 HCS Titanium Compression Screw	28	36.8
HCS243030	2.4/3.0 HCS Titanium Compression Screw	30	36.8
HCS243032	2.4/3.0 HCS Titanium Compression Screw	32	36.8
HCS243034	2.4/3.0 HCS Titanium Compression Screw	34	36.8
HCS243036	2.4/3.0 HCS Titanium Compression Screw	36	36.8
HCS243038	2.4/3.0 HCS Titanium Compression Screw	38	36.8
HCS243040	2.4/3.0 HCS Titanium Compression Screw	40	36.8

3.0/4.0 HCS Titanium Compression Screw **Veterinary Use Only** Titanium Grade 5

Unit mm



Code	Products Name	L	U.P.\$
HCS304012	3.0/4.0 HCS Titanium Compression Screw	12	36.8
HCS304014	3.0/4.0 HCS Titanium Compression Screw	14	36.8
HCS304016	3.0/4.0 HCS Titanium Compression Screw	16	36.8
HCS304018	3.0/4.0 HCS Titanium Compression Screw	18	36.8
HCS304020	3.0/4.0 HCS Titanium Compression Screw	20	36.8
HCS304022	3.0/4.0 HCS Titanium Compression Screw	22	36.8
HCS304024	3.0/4.0 HCS Titanium Compression Screw	24	36.8
HCS304026	3.0/4.0 HCS Titanium Compression Screw	26	36.8
HCS304028	3.0/4.0 HCS Titanium Compression Screw	28	36.8
HCS304030	3.0/4.0 HCS Titanium Compression Screw	30	36.8
HCS304032	3.0/4.0 HCS Titanium Compression Screw	32	36.8
HCS304034	3.0/4.0 HCS Titanium Compression Screw	34	36.8
HCS304036	3.0/4.0 HCS Titanium Compression Screw	36	36.8
HCS304038	3.0/4.0 HCS Titanium Compression Screw	38	36.8
HCS304040	3.0/4.0 HCS Titanium Compression Screw	40	36.8

# The Toggle Pin Method of Coxofemoral Luxation Repair

## Coxofemoral Luxation Repair Surgical Procedure

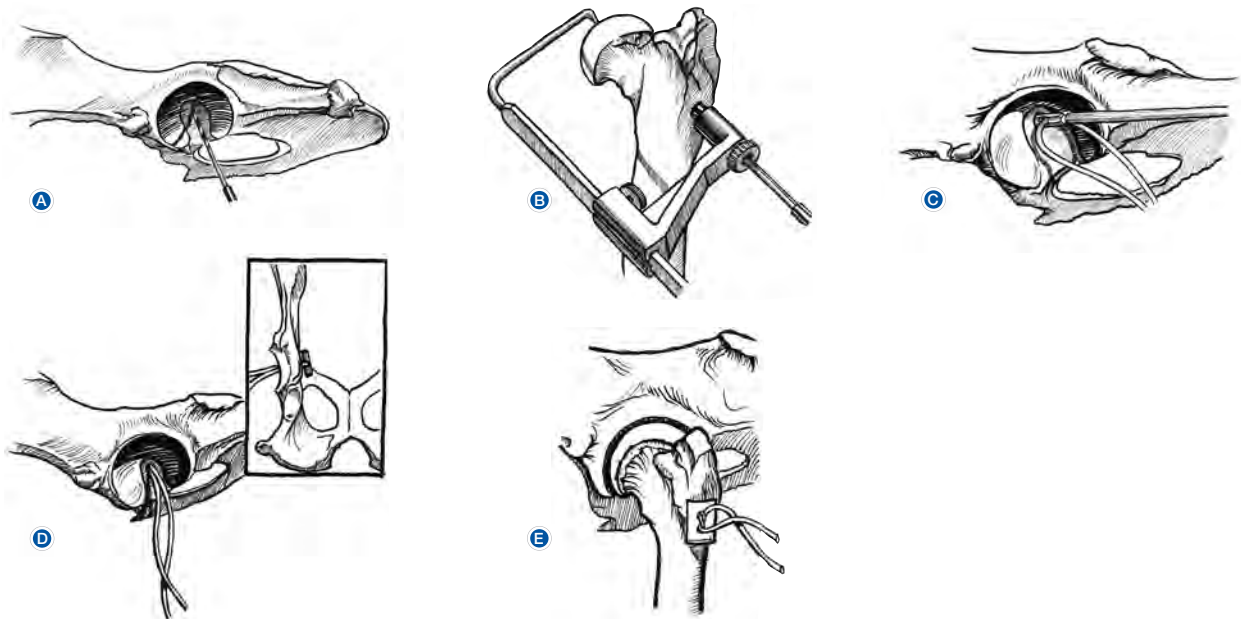

### Universal Aim Device

Veterinary Use Only

Code	Products Name/Specilaation	Quantity
	Universal Aim Device Set	
UAD0001	Universal Aim Device	1
UAD0015	Drill Sleeve 1.5mm	1
UAD0018	Drill Sleeve 1.8mm	1
UAD0020	Drill Sleeve 2.0mm	1
UAD0025	Drill Sleeve 2.5mm	1
UAD0027	Drill Sleeve 2.7mm	1
UAD0030	Drill Sleeve 3.0mm	1
UAD0035	Drill Sleeve 3.5mm	1
UAD0045	Drill Sleeve 4.5mm	1
UAD0002	Guide Pin	2
A32A15	1.5X85mm Drill Bits	1
A32A18	1.8X100mm Drill Bits	1
A32A20	2.0X100mm Drill Bits	1
A32A25	2.5X115mm Drill Bits	1
A32A27	2.7X165mm Drill Bits	1
A32A30	3.0X150mm Drill Bits	1
A32A35	3.5X150mm Drill Bits	1
A32A45	4.5X150mm Drill Bits	1
UAD0003	Universal Aim Device Diopter Sterilising Box	1



U.P.\$ 1064.5

# Suture And Anchor system

## Gelpi Self Retaining Retractor

Veterinary Use Only



Unit mm

Code	Products Name	L	U.P.\$
100152	Gelpi Self Retaining Retractor	140mm	93.5

## Large Stifle Distractor

Veterinary Use Only



Unit mm

Code	Products Name	L	U.P.\$
300001	Large Stifle Distractor	180mm	158.1

## Lateral Sutures with Crimp

Veterinary Use Only



Unit lb,cm

Code	Products Name	L	U.P.\$
AL075	Lateral Sutures	Lateral Sutures 75lb+Crimping 50cm	25.8
AL150	Lateral Sutures	Lateral Sutures 150lb+Crimping 60cm	25.8
AL250	Lateral Sutures	Lateral Sutures 250lb+Crimping 70cm	25.8



## Nylon Lateral Suture

Veterinary Use Only



Unit lb,cm

Code	Products Name	L	U.P.\$
AL060	Nylon Lateral Suture	Nylon Lateral Suture 60lb+Crimping 60mm	22.6
AL100	Nylon Lateral Suture	Nylon Lateral Suture 100lb+Crimping 60mm	22.6

## Crimping Forceps

Veterinary Use Only



Unit mm

Code	Products Name	U.P.\$
300002	Crimping Forceps	206.5



## Nylon Lateral Suture Scissor

Veterinary Use Only



Unit mm

Code	Products Name	L	U.P.\$
300003	Nylon Lateral Suture Scissor	145mm	93.5

## Ligament Tensioning Forceps

Veterinary Use Only



Unit mm

Code	Products Name	L	U.P.\$
300008	Ligament Tensioning Forceps	170mm	219.4



# Hip Toggle (Hip Toggles) Round Ligament Restablishment

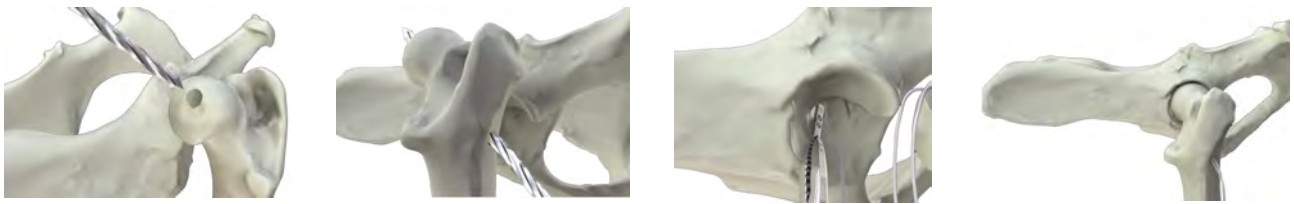

## Titanium Button

Veterinary Use Only

Titanium Grade 5



Code	Products Name	U.P.\$
TSB20	Two Holes Titanium Button	14.2
TSB40	Four Holes Titanium Button	17.4

## Hip Toggle

Veterinary Use Only

Titanium Grade 5



Unit mm

Code	Products Name	L	U.P.\$
TOG20	Hip Toggle	Ø2.0*15mm	14.2
TOG25	Hip Toggle	Ø2.5*20mm	14.2
TOG30	Hip Toggle	Ø3.0*25mm	14.2

## Hip Toggle+Lateral Sutures+Titanium Buttons

Veterinary Use Only



Unit Lb,mm

Code	Products Name/Speciaaation	U.P.\$
TOGSET20	Hip Toggle 2.0mm+Lateral Sutures 150Lb+Titanium Button	48.4
TOGSET25	Hip Toggle 2.5mm+Lateral Sutures 250Lb+Titanium Button	48.4
TOGSET30	Hip Toggle 2.0mm+Lateral Sutures 150Lb+Titanium Button	48.4

## Ligment Sutures Passer

Veterinary Use Only

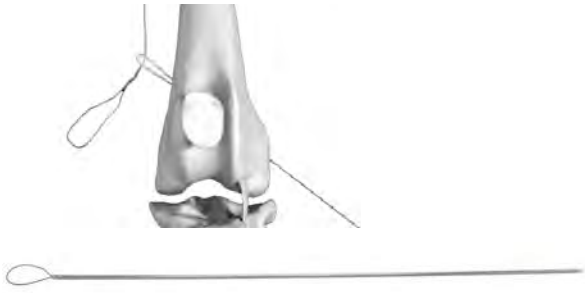

Unit mm

Code	Products Name	L	U.P.\$
300004	Ligment Sutures Passer	1.2X200mm	11

## Flexible Ligment Sutures Passer

Veterinary Use Only

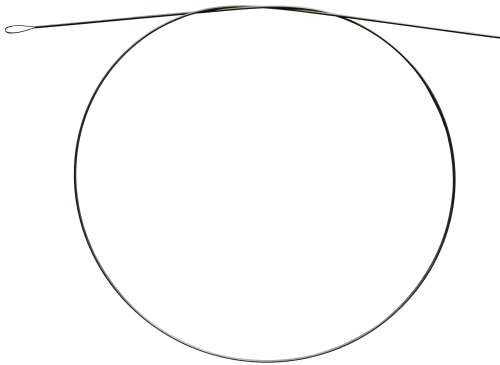

Unit mm

Code	Products Name	L	U.P.\$
300009	Flexible Ligment Sutures Passer	0.7X450mm	51.6

## Suture Anchor Pin

Veterinary Use Only Titanium Grade 5



Unit mm

Code	Products Name	L	U.P.\$
SAP25	Suture Anchor Pin	2.5mm	29
SAP30	Suture Anchor Pin	3.0mm	29
SAP40	Suture Anchor Pin	4.0mm	29



## FASTAK Suture Anchor

Veterinary Use Only

Titanium Grade 5

Unit mm



Code	Products Name	Speciliaation	U.P.\$
SAF047	FASTAK Suture Anchor	4.7mm	83.9
SAF028	FASTAK Suture Anchor	2.8mm	83.9
SAF802	FIBERWIRE Lateral Suture #2	80mm	74.2
SAF805	FIBERWIRE Lateral Suture #5	80mm	74.2
SAF128	FIBERWIRE Lateral Suture Set	2.8mm	206.5
SAF147	FIBERWIRE Lateral Suture Set	4.7mm	206.5



## Easy Lock Anchor

Veterinary Use Only

Titanium Grade 5

Unit mm



Code	Products Name	Speciliaation	U.P.\$
SAS2708	Easy Lock Anchor	2.7X8mm	38.7
SAS2710	Easy Lock Anchor	2.7X10mm	41.9
SAS3710	Easy Lock Anchor	3.7X10mm	41.9
SAS3712	Easy Lock Anchor	3.7X12mm	45.2
SAS4712	Easy Lock Anchor	4.7X12mm	45.2
SAS4716	Easy Lock Anchor	4.7X16mm	48.4



Code	Products Name	Speciliaation	U.P.\$
SAS001	Anchor Driver Small	Use 2.7 Anchors	96.8
SAS002	Anchor Driver Large	Use 3.7/4.7 Anchors	96.8



Code	Products Name	Speciliaation	U.P.\$
SAS000	Anchors Rack	2.7/3.7/4.7	271



# Femoral Head/Neck Excisional Arthroplasty



## Femoral Head/Neck Excisional Arthroplasty

Code	Products Name/Speciliaation	Quantity
THR0001	Femoral Head/Neck Excisional Arthroplasty	
100151/100152	Gelpi Self Retaining Retractor Curved 160mm	2
110156/110157	Double Head Skin Hook	2
100141	Small Hip Hohman 125mmX8mmX12mm	1
100140	Medium Hip Hohman 175mmX13mmX18mm	1
100139	Large Hip Hohman 255mmX25mmX36mm	1
300005	Hatt Spoon 280mm(20mmX30mm scoop)	1
300006	Hatt Spoon 260mm(12mmX18mm scoop)	1
300007	Hatt Spoon 230mm(8mmX12mm scoop)	1
100134/100135	Bone Rasp Curved/Straight(Choosable)	1
200003	Sterlization Container	1

U.P.\$ 625.5

## Hatt Spoon

Veterinary Use Only

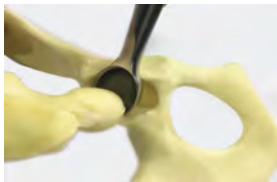

Unit mm

Code	Products Name	L	U.P.\$
300005	Hatt Spoon	280mm(20mmX30mm scoop)	93.5
300006	Hatt Spoon	260mm(12mmX18mm scoop)	93.5
300007	Hatt Spoon	230mm(8mmX12mm scoop)	93.5

## Canine Patellar Block

Veterinary Use Only

Titanium Grade 5



Unit mm

Code	Products Name	L	U.P.\$
E070	Canine Patellar Block	7mm	25.8
E080	Canine Patellar Block	8mm	25.8
E090	Canine Patellar Block	9mm	25.8
E100	Canine Patellar Block	10mm	25.8
E115	Canine Patellar Block	11.5mm	25.8
E130	Canine Patellar Block	13mm	25.8

# Lateral Sutures Anchor Instrument



## Lateral Sutures Anchor Instrument

Code	Products Name/Speciliaation	Quantity
AL0001	Lateral Sutures Anchor Instrument	
TOGSET20	Hip Toggle 2.0mm+Lateral Sutures 150Lb+Titanium Button	1
TOGSET25	Hip Toggle 2.5mm+Lateral Sutures 250Lb+Titanium Button	1
TOGSET30	Hip Toggle 3.0mm+Lateral Sutures 250Lb+Titanium Button	1
300004	Suture Passer $\phi$ 1.2mmX200mm	1
AL075	Lateral Sutures 50cm(Fiber Wire)	1
AL150	Lateral Sutures 60cm(Fiber Wire)	1
AL250	Lateral Sutures 70cm(Fiber Wire)	1
SAP25	Suture Anchor Pin 2.5mm	1
SAP30	Suture Anchor Pin 3.0mm	1
SAP40	Suture Anchor Pin 4.0mm	1
300002	Crimping Forceps	1
100152	Small Stifle Joint Distractor 140mm	1
300001	Large Stifle Distractor 180mm	1
300003	Nylon Lateral Suture Scissor 145mm	1
200003	Sterlization Container	1

U.P.\$ 962.5

# Skull Titanium Mesh System

## Skull Titanium Mesh System

Veterinary Use Only

Titanium Grade 5

Application Of Titanium Mesh In Craniotomy

Unit mm



Code	Products Name	Thickness	L	U.P.\$
Timesh405006	Titanium Mesh	0.6mm	40mmX50mm	432.3
Timesh506006	Titanium Mesh	0.6mm	50mmX60mm	451.6
Timesh607006	Titanium Mesh	0.6mm	60mmX70mm	496.8

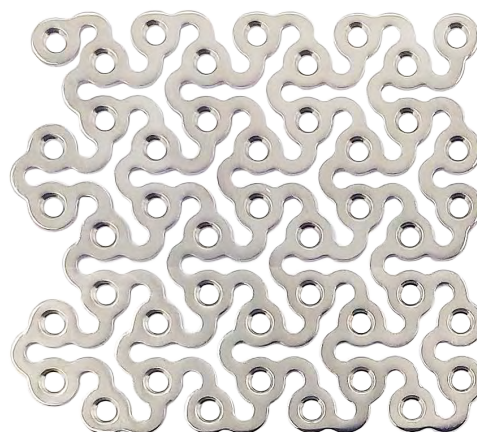

## Titanium Mesh Screw

Veterinary Use Only

Titanium Grade 5

Unit mm



Code	Products Name	Speciliaation	U.P.\$
Screw2005	Titanium Mesh Screw	1.5mmX4.0mm	15.8
Screw2006	Titanium Mesh Screw	1.5mmX5.0mm	15.8
Screw2008	Titanium Mesh Screw	1.5mmX6.0mm	15.8

## AO QC Cruciform Screwdriver

Veterinary Use Only

Unit mm



Code	Products Name	Speciliaation	U.P.\$
Timeshdi	AO QC Cruciform Screwdriver	Titanium Mesh Nail Dedicated	45.2

## Titanium Mesh Bending Forceps

Veterinary Use Only

Unit mm



Code	Products Name	L	U.P.\$
TimeshBnd	Titanium Mesh Bending Forceps	240mm	258.1



# Spinal Polyaxial Fixation System

## Rod Cutter

Veterinary Use Only



Unit mm

Code	Products Name	Specification	L	U.P.\$
600034	Rod Cutter	3/3.5mm	230mm	219

## Retractor Forceps

Veterinary Use Only



Unit mm

Code	Products Name	Opening Range	L	U.P.\$
600035	Retractor Forceps	50-0mm	230mm	165

## Compression Forceps

Veterinary Use Only



Unit mm

Code	Products Name	Opening Range	L	U.P.\$
600036	Compression Forceps	0-45mm	210mm	274

## Rod Holding Forceps

Veterinary Use Only



Unit mm

Code	Products Name	Specification	L	U.P.\$
600037	Rod Holding Forceps	3.0mm	190mm	71

## Screw Holding Forceps

Veterinary Use Only



Unit mm

Code	Products Name	L	U.P.\$
600038	Screw Holding Forceps	190mm	104

### Trail Rod

Veterinary Use Only

Unit mm



Code	Products Name	Specification	L	U.P.\$
600039	Trail Rod	3.0mm	200mm	19

### Nut Holder Hex

Veterinary Use Only

Unit mm



Code	Products Name	Specification	L	U.P.\$
600040	Nut Holder Hex	SW3.0	220mm	33

### Rod Pusher

Veterinary Use Only

Unit mm



Code	Products Name	U.P.\$
600041	Rod Pusher	66

### Pedicle Awl

Veterinary Use Only

Unit mm



Code	Products Name	U.P.\$
600042	Pedicle Awl	49

### Safety Awl

Veterinary Use Only

Unit mm



Code	Products Name	U.P.\$
600043	Safety Awl	77

### Screwdriver for Polyaxial Pedicle Screwial

Veterinary Use Only

Unit mm



Code	Products Name	L	U.P.\$
600044	Screwdriver for Polyaxial Pedicle Screwial	210mm	110

Feeler for Screw Channel, Straight

Veterinary Use Only

Unit mm

Code	Products Name	L	U.P.\$
600045	Feeler for Screw Channel, Straight	240mm	49



T Handle AO QC

Veterinary Use Only

Unit mm

Code	Products Name	U.P.\$
100159	T Handle AO QC	84



Nut Screwdriver Hex

Veterinary Use Only

Unit mm

Code	Products Name	Specification	L	U.P.\$
600046	Nut Screwdriver Hex	SW3.0	240mm	27



Torque Limiting Handle AO QC

Veterinary Use Only

Unit mm

Code	Products Name	Specification	U.P.\$
511.774	Torque Limiting Handle AO QC	4.0NM	271



Counter Torque

Veterinary Use Only

Unit mm

Code	Products Name	Specification	L	U.P.\$
600048	Counter Torque	3.0mm	210mm	96



In-Situ Bender(pair)

Veterinary Use Only

Unit mm

Code	Products Name	Specification	U.P.\$
600049	In-Situ Bender(pair)	Left	33
600050	In-Situ Bender(pair)	Right	33



## Bone Curette

Veterinary Use Only



Unit mm

Code	Products Name	Specification	Dia	L	U.P.\$
600005	Bone Curette	Large	3mm	150mm	52
600006	Bone Curette	Medium	2mm	150mm	52

## Polyaxial Pedicle Screws

Veterinary Use Only

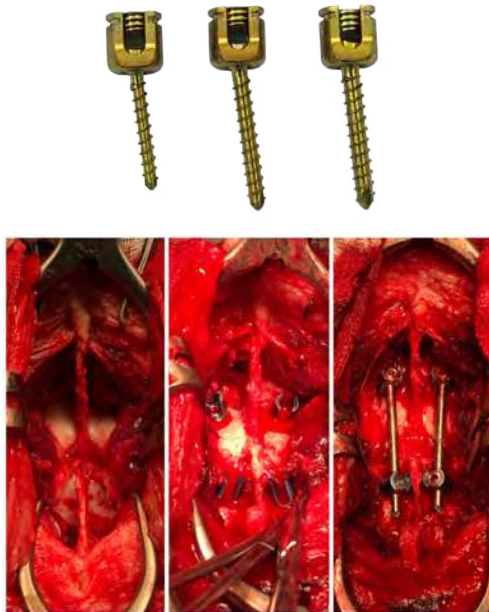

Unit mm

Code	Products Name	Dia	L	U.P.\$
600053	Polyaxial Pedicle Screws	2.7mm	14mm	84
600054	Polyaxial Pedicle Screws	2.7mm	16mm	84
600055	Polyaxial Pedicle Screws	2.7mm	18mm	84
600056	Polyaxial Pedicle Screws	2.7mm	20mm	84
600057	Polyaxial Pedicle Screws	2.7mm	22mm	84
600058	Polyaxial Pedicle Screws	2.7mm	24mm	84
600059	Polyaxial Pedicle Screws	3.2mm	16mm	84
600060	Polyaxial Pedicle Screws	3.2mm	18mm	84
600061	Polyaxial Pedicle Screws	3.2mm	20mm	84
600062	Polyaxial Pedicle Screws	3.2mm	22mm	84
600063	Polyaxial Pedicle Screws	3.2mm	24mm	84
600064	Polyaxial Pedicle Screws	3.2mm	26mm	84
600065	Polyaxial Pedicle Screws	3.5mm	16mm	84
600066	Polyaxial Pedicle Screws	3.5mm	18mm	84
600067	Polyaxial Pedicle Screws	3.5mm	20mm	84
600068	Polyaxial Pedicle Screws	3.5mm	22mm	84
600069	Polyaxial Pedicle Screws	3.5mm	24mm	84
600070	Polyaxial Pedicle Screws	3.5mm	26mm	84

## SPF Polyaxil Pedicle Screws Rack

Veterinary Use Only



Unit mm

Code	Products Name	U.P.\$
600051	SPF Polyaxil Pedicle Screws Rack	258

## Locking Nut

Veterinary Use Only



Unit mm

Code	Products Name	Specification	U.P.\$
600000	Locking Nut	SW3.0	13

## SPF Connecting Rod

Veterinary Use Only



Unit mm

Code	Products Name	Specification	U.P.\$
600071	SPF Connecting Rod	3X200mm	42

# Spinal Polyaxial Fixation System



## Spinal Polyaxial Fixation System

Code	Products Name/Specification	Quantity
	Spinal Polyaxial Fixation System	
600034	Rod Cutter Specification 3/3.5mm L 230mm	1
600035	Retractor Forceps Opening Range 50-0mm L 230mm	1
600036	Compression Forceps Opening Range 0-45mm L 210mm	1
600037	Rod Holding Forceps Specification 3.0mm L 190mm	1
600038	Screw Holding Forceps L 190mm	1
600039	Trail Rod Dia 3.0mm L 200mm	1
600040	Nut Holder Hex SW3.0 L 220mm	1
600041	Rod Pusher	1
600042	Pedicle Awl	1
600043	Safety Awl	1
600044	Screwdriver for Polyaxial Pedicle Screw L 210mm	1
600045	Feeler for Screw Channel, Straight L 240mm	1
100159	T Handle AO QC	1
600046	Nut Screwdriver Hex SW3.0 L 240mm	1
511.774	Torque Limiting Handle AO QC 4.0NM	1
600048	Counter Torque Specification 3.0 L 210mm	1
600049/600050	In-Situ Bender(pair) Specification Left/Right	2
600005/600006	Bone Curette Large Dia 3mm/Medium Dia 2mm L 150mm	2
600051	SPF Polyaxial Pedicle Screws Rack	1
600052	Spinal Polyaxial Fixation System Case 420mmX260mmX90mm	1

U.P.\$

2400



# Spinal Neuro Surgical Instruments

## Freer Periosteal Elevator

Veterinary Use Only

Unit mm

Code	Products Name	Specification	L	U.P.\$
600001	Freer Periosteal Elevator	5mm	185mm	58.1



## Very Fine Periosteal Elevator

Veterinary Use Only

Unit mm

Code	Products Name	Specification	L	U.P.\$
600002	Very Fine Periosteal Elevator	2/3mm	180mm	58.1



## Spinal Hook With Ball Tip

Veterinary Use Only

Unit mm

Code	Products Name	L	U.P.\$
600003	Spinal Hook With Ball Tip	150mm	58.1



## Freer Periosteal

Veterinary Use Only

Unit mm

Code	Products Name	L	U.P.\$
600004	Freer Periosteal	160mm	77.4



## Bone Curette

Veterinary Use Only

Unit mm



Code	Products Name	Specification	L	U.P.\$
600005	Bone Curette	Large 3mm	150mm	51.6
600006	Bone Curette	Medium 2mm	150mm	51.6
600007	Bone Curette	Small 1mm	150mm	51.6



## Bone Tamper

Veterinary Use Only

Unit mm



Code	Products Name	Specification	L	U.P.\$
600008	Bone Tamper	Large 2mm	150mm	41.9
600009	Bone Tamper	Small 1mm	150mm	41.9



## Spinal Hook

Veterinary Use Only

Unit mm

Code	Products Name	Specification	L	U.P.\$
600010	Spinal Hook	Large	220mm	51.6
600011	Spinal Hook	Small	180mm	51.6



## Rosen Mobiliser

Veterinary Use Only

Unit mm



Code	Products Name	L	U.P.\$
600012	Rosen Mobiliser	160mm	61.3



## Intervertebral Disc Distractor

Veterinary Use Only



Unit mm

Code	Products Name	Depth	U.P.\$
600013	Intervertebral Disc Distractor	90mm	93.5

## Spike&Shield Odd Leg Retractor

Veterinary Use Only



Unit mm

Code	Products Name	Specification	Quantity	L	U.P.\$
600014	Spike&Shield Odd Leg Retractor	22X22mm Shield	1 Pair	180mm	529
600015	Spike&Shield Odd Leg Retractor	12X12mm Shield	1 Pair	125mm	529

## Gelpi With Odd Legs

Veterinary Use Only



Unit mm

Code	Products Name	Open Depth	L	U.P.\$
600270	Gelpi With Odd Legs	20X30	140	100
600271	Gelpi With Odd Legs	30X20	140	100
600272	Gelpi With Odd Legs	25X40	180	109.7
600273	Gelpi With Odd Legs	40X25	180	109.7

## Gelpi With Safe Insertion Legs

Veterinary Use Only



Unit mm

Code	Products Name	Leg L	L	U.P.\$
600280	Gelpi Safe Insertion Legs	30	100	77.4
600281	Gelpi Safe Insertion Legs	15	140	77.4
600282	Gelpi Safe Insertion Legs	40	140	77.4
600283	Gelpi Safe Insertion Legs	20	180	83.9
600284	Gelpi Safe Insertion Legs	50	180	83.9
600285	Gelpi Safe Insertion Legs	60	200	93.5

## Cervical Disc Distractor

Veterinary Use Only



Unit mm

Code	Products Name	U.P.\$
600026	Cervical Disc Distractor	271

## Bone Cement

Veterinary Use Only



Unit g

Code	Products Name	Specification	U.P.\$
600025	Bone Cement	40g	158.1

## Kerrison Rongeur

Veterinary Use Only



Unit mm

Code	Products Name	Incision L	L	U.P.\$
600016	Kerrison Rongeur	1mm	200mm	271
600017	Kerrison Rongeur	2mm	200mm	254.8
600018	Kerrison Rongeur	3mm	200mm	254.8
600019	Kerrison Rongeur	4mm	200mm	254.8
600020	Kerrison Rongeur	5mm	200mm	254.8

## Kerrison Punch Rongeur

Veterinary Use Only



Unit mm

Code	Products Name	Incision L	L	U.P.\$
600021	Kerrison Punch Rongeur	2mm	230mm	271
600022	Kerrison Punch Rongeur	3mm	230mm	271
600023	Kerrison Punch Rongeur	4mm	230mm	271
600024	Kerrison Punch Rongeur	5mm	230mm	271

# Micro Spine Rongeur

Veterinary Use Only

Unit mm

Code	Products Name/Specification	Cutting Width	L	U.P.\$
600072	Micro Spine Rongeur/STR	1.75mm	135mm	98
600073	Micro Spine Rongeur/Angular	1.75mm	135mm	98
600074	Micro Spine Rongeur/CVD	1.75mm	135mm	98



## BIORTHO Rotating Kerrison Rongeur

Veterinary Use Only

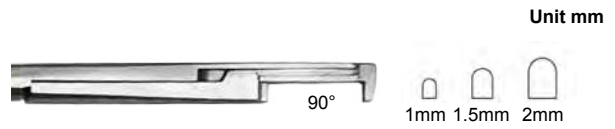
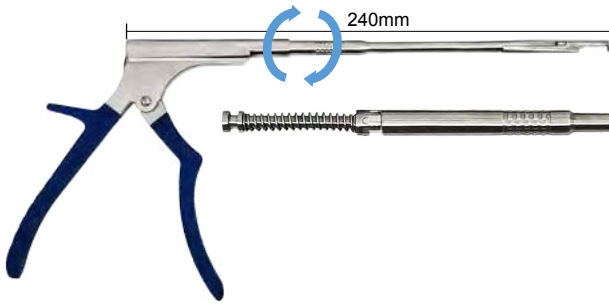

Code	Products Name/Specification	Cutting Width	L	U.P.\$
600027	Biortho Rotating Kerrison Rongeur 90°	1mm	240mm	206.5
600028	Biortho Rotating Kerrison Rongeur 90°	1.5mm	240mm	206.5
600029	Biortho Rotating Kerrison Rongeur 90°	2mm	240mm	206.5



Code	Products Name/Specification	Cutting Width	L	U.P.\$
600030	Biortho Rotating Kerrison Rongeur 130°	1mm	240mm	206.5
600031	Biortho Rotating Kerrison Rongeur 130°	1.5mm	240mm	206.5
600032	Biortho Rotating Kerrison Rongeur 130°	2mm	240mm	206.5

Code	Products Name	U.P.\$
600033	BIORTHO Rotating Kerrison Rongeur Handle	310

## Cervical Distraction Instruments Set

Veterinary Use Only

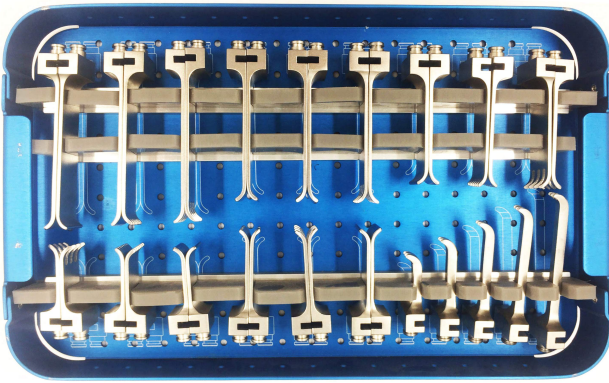

Code	Products Name	U.P.\$
601001	Cervical Distraction Instruments Set	2709.7



# Spine Neuro Surgery

## Spinal Neurosurgery High Speed Drill

Pen Type Drill Chuck



Superspeed Electrical Motor



Sterilising Box

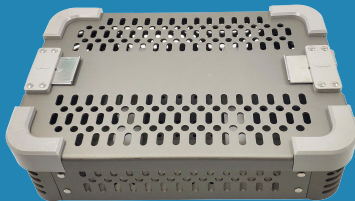

Foot switch



- Specialty-driven handpieces
- Increased power, precision burring
- OR standardization



### Spinal Neurosurgery High Speed Drill Set

Veterinary Use Only

Code	Products Name	U.P.\$
700008	Spinal Neurosurgery High Speed Drill Set	6419.4

### Neurosurgical High Speed Grinding Bur

Veterinary Use Only

Unit mm



High Speed Alloy Grinding Bur



High Speed Diamond Grinding Bur

Code	Products Name	Specification	L	U.P.\$
R1070	High Speed Alloy Grinding Bur	1.0mm	70mm	109.7
R2070	High Speed Alloy Grinding Bur	2.0mm	70mm	109.7
R3070	High Speed Alloy Grinding Bur	3.0mm	70mm	109.7
R4070	High Speed Alloy Grinding Bur	4.0mm	70mm	109.7
R5070	High Speed Alloy Grinding Bur	5.0mm	70mm	109.7
D1070	High Speed Diamond Grinding Bur	1.0mm	70mm	109.7
D2070	High Speed Diamond Grinding Bur	2.0mm	70mm	109.7
D3070	High Speed Diamond Grinding Bur	3.0mm	70mm	109.7
D4070	High Speed Diamond Grinding Bur	4.0mm	70mm	109.7
D5070	High Speed Diamond Grinding Bur	5.0mm	70mm	109.7

# Orthopedic Power Tool System



## BW 7.2V Cannulated Drill Set

Veterinary Use Only

Unit mm



Code	Products Name	Specification	U.P.\$
700001	Cannulated Drill Set	BW 7.2V	1429

## BW 7.2V Battery

Veterinary Use Only

Unit mm



Code	Products Name	Specification	U.P.\$
700010	Battery	BW 7.2V	141.9

## BW 7.2V Battery Chargers

Veterinary Use Only

Unit mm



Code	Products Name	Specification	U.P.\$
700011	Battery Chargers	BW 7.2V	171

## BW 7.2V Drill key

Veterinary Use Only

Unit mm



Code	Products Name	Specification	U.P.\$
700023	Drill key	BW 7.2V	19.4



## BW 7.2V Battery Powered Saw

Veterinary Use Only



Code	Products Name	Specification	U.P.\$
70002	Battery Powered Saw	BW 7.2V	1238.7

## BW Series Saw Blades

Veterinary Use Only

Unit mm

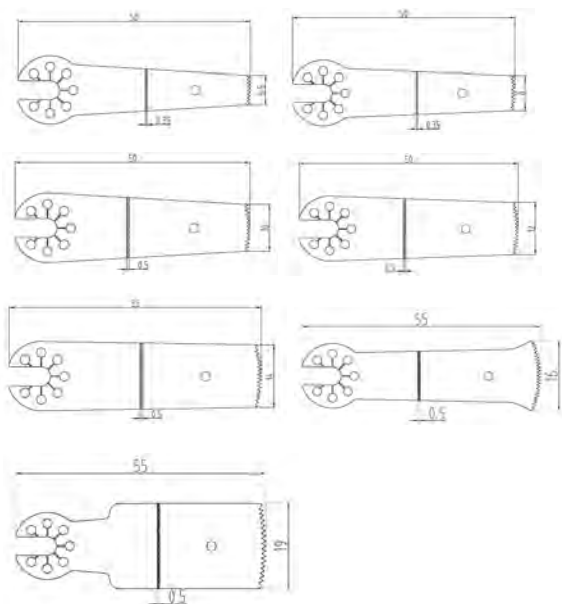

Code	Products Name	Incision Thickness	Width	L	U.P.\$
700165	Series Saw Blades	0.35	6.5	50	74.2
700180	Series Saw Blades	0.35	8.0	50	74.2
700110	Series Saw Blades	0.50	10	50	74.2
700112	Series Saw Blades	0.50	12	50	74.2
700114	Series Saw Blades	0.50	14	55	74.2
700116	Series Saw Blades	0.50	16	50	74.2
700119	Series Saw Blades	0.50	19	55	74.2

### Cannulated Jacob Attachment

Veterinary Use Only



Unit mm

Code	Products Name	U.P.\$
700013	Cannulated Jacob Attachment	574.2

### AO QC Attachment

Veterinary Use Only



Unit mm

Code	Products Name	U.P.\$
700014	AO QC Attachment	493.5

### Sagittal Saw Attachment

Veterinary Use Only



Unit mm

Code	Products Name	U.P.\$
700015	Sagittal Saw Attachment	783.9

### K Wire Chuck Attachment

Veterinary Use Only



Unit mm

Code	Products Name	Dia	U.P.\$
700016	K Wire Chuck Attachment	0.8-2.5mm	671

### Sterilization Case

Veterinary Use Only



Unit mm

Code	Products Name	U.P.\$
700012	Sterilization Case	190.3

# BW 7.2V Multi-Function Drill

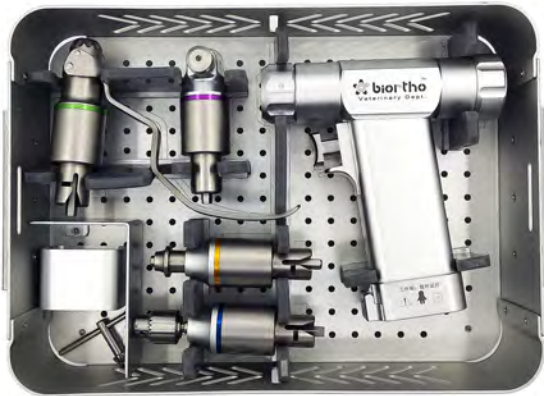

## BW 7.2V Multi-Function Drill

Code	Products Name/Specification	Quantity
700003	BW 7.2V Hand Piece Cannulated 0-2.5mm	1
700013	Cannulated Jacob Attachment	1
700014	AO QC Attachment	1
700015	Sagittal Saw Attachment	1
700016	K Wire Chuck Attachment 0.8-2.5mm	1
700010	BW 7.2V Battery	2
700011	BW 7.2V Battery Chargers	1
700012	Sterilization Case	1

U.P.\$ 4080.6

## Power Tool Repair Service

Veterinary Use Only



Code	Products Name	U.P.\$
7R0001	Internal Gears	129
7R0002	Normal Motor	161.3
7R0003	Cannulated Motor	225.8
7R0004	Normal Motor With Gears	193.5
7R0005	Bearing	129
7R0006	Speed Controlling Trigger	64.5
7R0007	Power Switch	64.5
7R0008	Quick Coupling Repairing ( Main Piece)	96.8
7R0009	Quick Coupling Repairing ( Attachment)	96.8
7R0010	Change New Jacob Chuck	96.8
7R0011	Sagittal Saw Attachment Repairing	96.8
7R0012	K wire Chuck Attachment Repairing	161.3
7R0013	Change Main Piece Handle	161.3
7R0014	Battery Repairing	64.5
7R0015	Battery Charger Repairing	64.5

**BW 14.4V Cannulated Drill Set**

Veterinary Use Only

Unit mm



Code	Products Name	Specification	U.P.\$
700004	Cannulated Drill Set	BW 14.4V	1106.5

**BW 14.4V Battery**

Veterinary Use Only

Unit mm



Code	Products Name	Specification	U.P.\$
700020	Battery	BW 14.4V	138.7

**BW 14.4V Battery Chargers**

Veterinary Use Only

Unit mm



Code	Products Name	Specification	U.P.\$
700021	Battery Chargers	BW 14.4V	171

**BW 14.4V Drill key**

Veterinary Use Only

Unit mm



Code	Products Name	Specification	U.P.\$
700024	Drill key	BW 14.4V	19.4

**BW 14.4V Battery Powered Saw**

Veterinary Use Only



Unit mm

Code	Products Name	Specification	U.P.\$
700005	Battery Powered Saw	BW 14.4V	1106.5

**BW Orthopedic Plaster Saw**

Veterinary Use Only



Unit mm

Code	Products Name	U.P.\$
700007	BW Orthopedic Plaster Saw	719.4

**14.4V Drill Sterilization Case**

Veterinary Use Only



Unit mm

Code	Products Name	U.P.\$
700022	14.4V Drill Sterilization Case	254.8

# Basic Surgical Operating Instrument

## Mayo Safety Pin

Veterinary Use Only



Unit mm

Code	Products Name	L	U.P.\$
500000	Mayo Safety Pin	140mm	11

## Crile Artery Forceps

Veterinary Use Only



Unit mm

Code	Products Name	Specification	L	U.P.\$
500004	Crile Artery Forceps	Straight	140mm	12.6
500003	Crile Artery Forceps	Curved	140mm	12.6
500005	Crile Artery Forceps	Straight	160mm	12.6
500006	Crile Artery Forceps	Curved	160mm	12.6

## Halsted-Mosquito

Veterinary Use Only



Unit mm

Code	Products Name	Specification	L	U.P.\$
500001	Halsted-Mosquito	Straight	125mm	11
500002	Halsted-Mosquito	Curved	125mm	11

## Allis Tissue Forceps

Veterinary Use Only



Unit mm

Code	Products Name	Specification	L	U.P.\$
500007	Allis Tissue Forceps	4X5 Teeth	150mm	14.2
510007	Allis Tissue Forceps	4X5 Teeth	125mm	15.8

# Basics Surgical Operating Instrument

## Dressing-Blunt/Sharp

Veterinary Use Only



Unit mm

Code	Products Name	Specification	L	U.P.\$
500008	Dressing-Blunt/Sharp	Straight	145mm	15.8
500009	Dressing-Blunt/Sharp	Curved	145mm	15.8

## Dressing-Sharp/Sharp

Veterinary Use Only



Unit mm

Code	Products Name	Specification	L	U.P.\$
500010	Dressing-Sharp/Sharp	Straight	145mm	14.2
500011	Dressing-Sharp/Sharp	Curved	145mm	14.2
500039	Dressing-Sharp/Sharp	Straight	165mm	15.8
500040	Dressing-Sharp/Sharp	Curved	165mm	15.8
500041	Dressing-Sharp/Sharp	Straight	115mm	14.2
500042	Dressing-Sharp/Sharp	Curved	115mm	14.2

## Operating Scissors Blunt

Veterinary Use Only



Unit mm

Code	Products Name	Specification	L	U.P.\$
500043	Operating Scissors Blunt	Straight	145mm	15.8
500044	Operating Scissors Blunt	Curved	145mm	15.8
500045	Operating Scissors Blunt	Straight	165mm	15.8
500046	Operating Scissors Blunt	Curved	165mm	15.8

## Stitch-Cutting Scissors

Veterinary Use Only



Unit mm

Code	Products Name	L	U.P.\$
500047	Stitch-Cutting Scissors	150mm	17.4

# Basics Surgical Operating Instrument

## Metzenbaum Supercut T.C

Veterinary Use Only



Unit mm

Code	Products Name	Specification	L	U.P.\$
500013	Metzenbaum Supercut T.C	Straight	145mm	77.4
500014	Metzenbaum Supercut T.C	Curved	145mm	77.4

## Surgical Scissor-Supercut T.C

Veterinary Use Only



Unit mm

Code	Products Name	Specirgcatiin	L	U.P.\$
500015	Surgical Scissor-Supercut T.C	Straight	150mm	74.2
500016	Surgical Scissor-Supercut T.C	Curved	150mm	74.2

## Goldmann Fox T.C Supercut

Veterinary Use Only



Unit mm

Code	Products Name	Specirgcatiin	L	U.P.\$
500048	Goldmann Fox T.C Supercut	Straight tip	130mm	45.2

## Iris Scissors

Veterinary Use Only



Unit mm

Code	Products Name	Specirgcatiin	L	U.P.\$
500012	Iris Scissors	Straight tip	115mm	67.7

## Bandage Scissor

Veterinary Use Only



Unit mm

Code	Products Name	L	U.P.\$
500074	Bandage Scissor	150mm	16.1
500075	Bandage Scissor	180mm	17.7



## Mayo Hegar T.C.Jaws(3mm Width)

Veterinary Use Only



Unit mm

Code	Products Name	L	U.P.\$
500017	Mayo Hegar T.C.Jaws	125mm	58.1
500018	Mayo Hegar T.C.Jaws	140mm	61.3
500019	Mayo Hegar T.C.Jaws	160mm	61.3

## Ryder(Micro)T.C.Jaws

Veterinary Use Only



Unit mm

Code	Products Name	L	U.P.\$
500020	Ryder(Micro)T.C.Jaws	150mm	74.2
500021	Ryder(Micro)T.C.Jaws	135mm	77.4

## Olsen Hegar Needle Holders"s"cut T.C.Jaws

Veterinary Use Only



Unit mm

Code	Products Name	L	U.P.\$
500022	Olsen Hegar Heedle Holder TC Jaws	140mm	106.5
500023	Olsen Hegar Heedle Holder TC Jaws	160mm	109.7
500077	Olsen Hegar Heedle Holder	140mm	58
500078	Olsen Hegar Heedle Holder	160mm	61.3

## Gillies Olsen Hegar Needle Holders

Veterinary Use Only



Unit mm

Code	Products Name	L	U.P.\$
500049	Gillies Olsen Hegar Needle Holders-Left Hand	160mm	174.2
500050	Gillies Olsen Hegar Needle Holders-right Hand	160mm	206.5

# Dissecting Forceps

## Dissecting Forceps

Veterinary Use Only

Unit mm



Code	Products Name	L	U.P.\$
500024	Dissecting Forceps-1/2 Teeth Ring Gold	150mm	14.2
500079	Dissecting Forceps-1/2 Teeth Ring Gold	180mm	16
500080	Dissecting Forceps-Serrated	180mm	16

## DeBakey Dessecting Forceps

Veterinary Use Only

Unit mm



Code	Products Name	L	U.P.\$
500027	DeBakey Dessecting Forceps-Serrated Dissecting	125mm	41.9
500027b	DeBakey Dessecting Forceps-1/2 Teeth	125mm	41.9



## Adson Forceps

Veterinary Use Only

Unit mm



Code	Products Name	U.P.\$
500028	Adson Serrated Dissecting Forceps	19.4
500029	Adson Dissecting Forceps 1/2 Teeth	19.4
500030	Adson DeBakey Dissecting Forceps	35.5
500031	Adson Brown Dissecting Forceps	29
500076	Adson Tissue Forceps	19.4

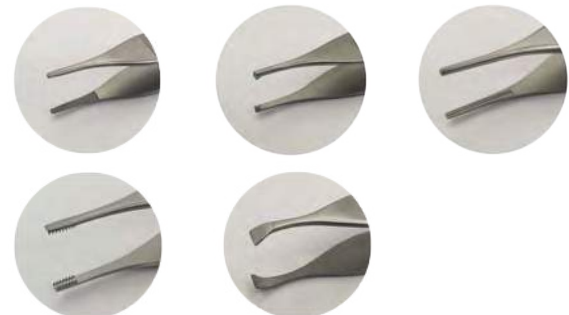

## Standard Scalpel Handles

Veterinary Use Only

Unit mm



Code	Products Name	Specircgatiin	U.P.\$
500036	Standard Scalpel Handles	NO-3	4.5
500037	Standard Scalpel Handles	NO-4	4.8

## Backhuas Towel Forceps

Veterinary Use Only



Unit mm

Code	Products Name	L	U.P.\$
500032	Backhuas Towel Forceps	100mm	11
500033	Backhuas Towel Forceps	125mm	12.6

## Ball and Socket Towel Clamp

Veterinary Use Only



Unit mm

Code	Products Name	L	U.P.\$
500034	Ball and Socket Towel Clamp	100mm	20.6
500035	Ball and Socket Towel Clamp	125mm	22.3

## Jones Towel Forceps

Veterinary Use Only



Unit mm

Code	Products Name	L	U.P.\$
500038	Jones Towel Forceps	90mm	14.2

## Intestinal Clamp

Veterinary Use Only



Unit mm

Code	Products Name	Specirgcatiin	L	U.P.\$
500051	Intestinal Clamp	Straight	220mm	45.2
500052	Intestinal Clamp	Curved	220mm	45.2

## Baby satinsky

Veterinary Use Only



Unit mm

Code	Products Name	L	U.P.\$
500068	Baby satinsky	150mm	90.3

## Soft Palate Forceps

Veterinary Use Only



Unit mm

Code	Products Name	Specirgcatiin	U.P.\$
500070S	Soft Palate Forceps	18X7X170mm	90.3
500070L	Soft Palate Forceps	26X12X170mm	90.3



## Spay Forceps With Hook

Veterinary Use Only



Unit mm

Code	Products Name	L	U.P.\$
500065	Spay Forceps With Hook	140mm	29
500066	Spay Forceps With Hook	160mm	29

## Spay Hook

Veterinary Use Only



Unit mm

Code	Products Name	L	U.P.\$
500061	Spay Hook	180mm	30.3
500062	Spay Hook	150mm	31.9

## Mouth Gags for Cats

Veterinary Use Only



Unit mm

Code	Products Name	Specirgcatiin	Opening Range	U.P.\$
500054	Mouth Gags for Cats	Small	25mm-75mm	43.2
500055	Mouth Gags for Cats	Medium	30mm-100mm	40
500056	Mouth Gags for Cats	Large	30mm-145mm	36.8

## Mouth Gags for Dogs

Veterinary Use Only



Unit mm

Code	Products Name	Specirgcatiin	Opening Range	U.P.\$
500057	Mouth Gags for Dogs	Small	40mm-90mm	35.2
500058	Mouth Gags for Dogs	Medium	40mm-110mm	38.4
500059	Mouth Gags for Dogs	Large	50mm-170mm	41.6

## Rodent Mouth Gag

Veterinary Use Only



Unit mm

Code	Products Name	Specirgcatiin	Opening Range	U.P.\$
500060	Rodent Mouth Gag			106.5
500071	Cheek Dilator	Small	50mm	25.8
500072	Cheek Dilator	Medium	70mm	25.8
500073	Cheek Dilator	Large	90mm	25.8

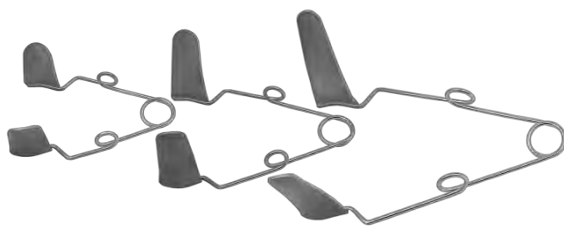

## Rabbit Mouth Gag

Veterinary Use Only



Unit mm

Code	Products Name	Opening Range	L	U.P.\$
500069	Rabbit Mouth Gag	43mm	117mm	96.8

## Tongue Forceps

Veterinary Use Only



Unit mm

Code	Products Name	L	U.P.\$
500053	Tongue Forceps	170mm	61.3

## Gosset Retractors

Veterinary Use Only



Unit mm

Code	Products Name	Maximum Opening Range	U.P.\$
500063	Gosset Retractors	100mm	271

## Balfour Retractors

Veterinary Use Only

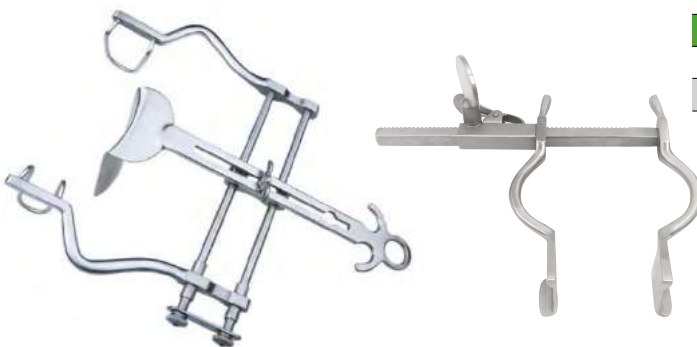

Unit mm

Code	Products Name	Maximum Opening Range	U.P.\$
500064S	Balfour Retractors	120mm	303
500064	Balfour Retractors	180mm	303

## West Retractors

Veterinary Use Only



Unit mm

Code	Products Name	Maximum Opening Range	U.P.\$
500067	West Retractors	140mm	352

# Soft Tissue Surgical Instruments Kit



## Soft Tissue Surgical Instruments Kit

### Soft Tissue Surgical Instruments Kit A

Code	Products Name/Specification	Quantity
000012	Soft Tissue Surgical Instruments Kit A	
500000	Mayo Safety Pin	1
500005	Crile Artery Forceps-Straight 160/140	3
500006	Crile Artery Forceps-Curved 160/140	3
500007	Allis Tissue Forceps	2
500033	Backhuas Towel Forceps 125/100	4
500039	Dressing	1
500013	Metzenbaum Supercut T.C-Straight 140mm	1
500014	Metzenbaum Supercut T.C-Curved 140mm	1
500019	Mayo Hegar T.C.Jaws 160/140	1
500028	Adson Serrated Dissecting Forceps	1
500029	Adson Dissecting Forceps 1/2 Teeth	1
500036	Standard Scalpel Handles No.3/No.4	1
200003	Sterilization Case	1

U.P.\$ 530.9

### Soft Tissue Surgical Instruments Kit B

Code	Products Name/Specification	Quantity
000013	Soft Tissue Surgical Instruments Kit B	
500000	Mayo Safety Pin	1
500006	Crile Artery Forceps-Curved 160/140	4
500001	Halsted-Mosquito-Straight 125	2
500002	Halsted-Mosquito-Curved 125	2
500007	Allis Tissue Forceps	2
500035	Ball and Socket Towel Clamp 125/100	4
500039	Dressing	1
500015	Surgical Scissor-Supercut T.C.-Straight 150mm	1
500014	Metzenbaum Supercut T.C-Curved 140mm	1
500048	Iris Scissors Straight/Sharp 115mm	1
500023	Olsen Hegar Needle holders"s"cut T.C.Jaws 160/140	1
500028	Adson Serrated Dissecting Forceps	1
500029	Adson Dissecting Forceps 1/2 Teeth	1
500031	Adson Brown Dissecting Forceps	1
500036	Standard Scalpel Handles NO.3/NO.4	1
200003	Sterilization Case	1

U.P.\$ 707.9

# Spay Kit



## Spay Kit

### Canine Spay Kit

Code	Products Name/Specification	Quantity
000014	Canine Spay Kit	
500015	Surgical Scissor Supercut T.C.Straight 150mm	1
500004	Crile Artery Forceps Straight 140mm	2
500006	Crile Artery Forceps Curved 160mm	2
500002	Halsted Mosquito Curved 125mm	2
500038	Jones Towel Forceps 90mm	4
500007	Allis Tissue Forceps 150mm	2
500024	Dissecting Forceps 1/2 Teeth Ring Gold	1
500023	Olsen Hegar Needle holders"s"cut T.C.Jaws 160mm	1
500031	Adson Serrated Dissecting Forceps	1
500036	Standard Scalpel Handles No.3/No.4	1
500061	Spay Hook	1
200003	Sterilization Case	1

U.P.\$ 509.8

### Feline Spay Kit

Code	Products Name/Specification	Quantity
000014F	Feline Spay Kit	
500013	Metzenbaum Supercut T.C.Straight 140mm	1
500006	Crile Artery Forceps Curved 160mm	2
500004	Crile Artery Forceps Straight 140mm	2
500002	Halsted Mosquito Curved 125mm	2
510007	Allis Tissue Forceps 125mm	2
500038	Jones Towel Forceps 90mm	4
500024	Dissecting Forceps 1/2 Teeth Ring Gold	1
500022	Olsen Hegar Needle holders"s"cut T.C.Jaws 140mm	1
500031	Adson Brown Dissecting Forceps	1
500062	Spay Hook	1
500036	Standard Scalpel Handles NO-3/NO-4	1
200003	Sterilization Case	1

U.P.\$ 514.6



# Dental Instruments

## Sickle Scaler

Veterinary Use Only

Unit mm



Code	Products Name	L	U.P.\$
800001	Sickle Scaler	170mm	14.2

## Very Fine Periosteal Elevator

Veterinary Use Only

Unit mm



Code	Products Name	Cutting Edge	L	U.P.\$
800002	Very Fine Periosteal Elevator	2/4mm	170mm	30.3

## Explorer/Measuring Probe

Veterinary Use Only

Unit mm



Code	Products Name	L	U.P.\$
800003	Explorer/Measuring Probe	170mm	15.8

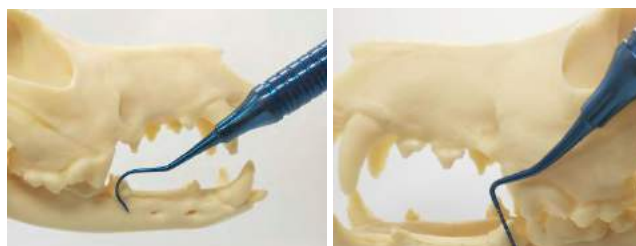

## Jaquette Supragingival Scaler

Veterinary Use Only

Unit mm



Code	Products Name	L	U.P.\$
800004	Jaquette Supragingival Scaler	170mm	15.8



## Subgingival Curette

Veterinary Use Only



Unit mm

Code	Products Name	L	U.P.\$
800005	Subgingival Curette	170mm	15.8

## Tartar Removing Forceps

Veterinary Use Only



Unit mm

Code	Products Name	L	U.P.\$
800006	Tartar Removing Forceps	125mm	35.2

## Extraction Forceps

Veterinary Use Only



Unit mm

Code	Products Name	L	U.P.\$
800007	Extraction Forceps	125mm	35.2

## Fragment Extraction Forceps

Veterinary Use Only



Unit mm

Code	Products Name	L	U.P.\$
800015	Fragment Extraction Forceps	140mm	62.6

## Minnesota Retractor

Veterinary Use Only



Unit mm

Code	Products Name	L	U.P.\$
800012	Minnesota Retractor	155mm	11

## Winged Elevator

Veterinary Use Only



Unit mm

Code	Products Name	Head Width	L	U.P.\$
800008	Winged Elevator	1mm	150mm	30.3
800009	Winged Elevator	2mm	150mm	30.3
800010	Winged Elevator	3mm	150mm	30.3
800011	Winged Elevator	4mm	150mm	30.3

## Straight Root Tip Pick

Veterinary Use Only



Unit mm

Code	Products Name	L	U.P.\$
800013	Straight Root Tip Pick	150mm	31.9

## Periosteal Elevator

Veterinary Use Only



Unit mm

Code	Products Name	L	U.P.\$
800014	Periosteal Elevator	150mm	31.9

# Small Animal Dental Instruments Set



## Small Animal Dental Instruments Set

Code	Products Name/Specification	Quantity
000015A	Small Animal Dental Instruments Set	
800001	Sickle Scaler	1
800002	Very Fine Periosteal Elevator	1
800003	Explorer/Measuring Probe	1
800004	Jaquette Supragingival Scaler	1
800005	Subgingival Curette	1
800006	Tartar Removing Forceps	1
800007	Extraction Forceps	1
800008	Winged Elevator 1mm	1
800009	Winged Elevator 2mm	1
800010	Winged Elevator 3mm	1
800011	Winged Elevator 4mm	1
800012	Minnesota Retractor	1
800013	Straight Root Tip Pick	1
800014	Periosteal Elevator	1
800015	Fragment Extraction Forceps	1
000015E	Sterilization Case 265X185X75mm	1

U.P.\$

595

# Rodent Dental Instruments

## Up Incisor Teeth Dental Elevator

Veterinary Use Only

Unit mm

Code	Products Name	L	U.P.\$
800016	Up Incisor Teeth Dental Elevator	200mm	31.9



## Descend Incisor Teeth Dental Elevator

Veterinary Use Only

Unit mm

Code	Products Name	L	U.P.\$
800017	Descend Incisor Teeth Dental Elevator	200mm	31.9



## Incisor Teeth Dental Elevator

Veterinary Use Only

Unit mm

Code	Products Name	L	U.P.\$
800018	Incisor Teeth Dental Elevator	200mm	31.9



## Grind Teeth Dental Elevator

Veterinary Use Only

Unit mm

Code	Products Name	L	U.P.\$
800019	Grind Teeth Dental Elevator	165mm	31.9



## Rodent Teeth Rasp

Veterinary Use Only

Unit mm

Code	Products Name	L	U.P.\$
800020	Rodent Teeth Rasp	180mm	31.9



## Rodent Tongue Depressor

Veterinary Use Only

Unit mm



Code	Products Name	L	U.P.\$
800021	Rodent Tongue Depressor	180mm	27.1

## Rodent Lip Buccal Pressing Plate

Veterinary Use Only

Unit mm



Code	Products Name	L	U.P.\$
800022	Rodent Lip Buccal Pressing Plate	150mm	27.1

## Grind Teeth Shear

Veterinary Use Only

Unit mm



Code	Products Name	L	U.P.\$
800023	Grind Teeth Shear	180mm	59.4

## Rodent Extraction Forceps

Veterinary Use Only

Unit mm



Code	Products Name	L	U.P.\$
800024	Rodent Extraction Teeth Forceps	150mm	59.4



## Rodent Mouth Gag(Wire Type)

Veterinary Use Only

Unit mm



Code	Products Name	Opening Range	U.P.\$
800025	Rodent Mouth Gag(Wire Type)	70mm	16.1

### Cheek Side Dilator

Veterinary Use Only



Unit mm

Code	Products Name	Specification	Opening Range	U.P.\$
800026	Cheek Side Dilator	Small	40mm	25.8
800027	Cheek Side Dilator	Medium	50mm	25.8
800028	Cheek Side Dilator	Large	60mm	25.8

### Cheek Side Dilator(Long Reach Curved)

Veterinary Use Only



Unit mm

Code	Products Name	Specification	Opening Range	U.P.\$
500071	Cheek Side Dilator	Small	40mm	25.8
500072	Cheek Side Dilator	Medium	50mm	25.8
500073	Cheek Side Dilator	Large	60mm	25.8

### Table Top Mouth Gag(Rabbit/Rodent)

Veterinary Use Only



Unit mm

Code	Products Name	U.P.\$
800029	Table Top Mouth Gag	235.5

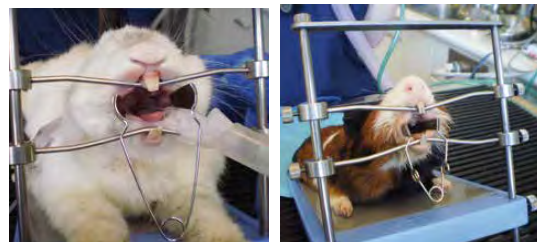

### Table Top Mouth Gag Adjustable

Veterinary Use Only



Unit mm

Code	Products Name	U.P.\$
800030	Table Top Mouth Gag Adjustable	338.7

# Rodent Dental Instrument Set



## Rodent Dental Instrument Set

Code	Products Name/Specification	Quantity
800016	Up Incisor Teeth Dental Elevator	1
800017	Descend Incisor Teeth Dental Elevator	1
800018	Incisor Teeth Dental Elevator	1
800019	Grind Teeth Dental Elevator	1
800020	Rodent Teeth Rasp	1
800021	Rodent Tongue Depressor	1
800022	Rodent Lip Buccal Pressing Plate	1
800023	Grind Teeth Shear	1
800024	Rodent Extraction Forceps	1
800026	Small Cheek Side Dilator	1
800027	Medium Cheek Side Dilator	1
800028	Large Cheek Side Dilator	1
100079	Micro Friedman Rongeur Curved	1
200005	Sterilization Case	1

U.P.\$

577.6



# Ophthalmology Surgery Instrument Set

## Halstead Mosquito Forceps

Veterinary Use Only



Unit mm

Code	Products Name	Specification	L	U.P.\$
900001	Halstead Mosquito Forceps	Straight	95mm	11
900002	Halstead Mosquito Forceps	Curved	95mm	11

## Standard Scalpel Handles

Veterinary Use Only



Unit mm

Code	Products Name	U.P.\$
500036	NO-3 Standard Scalpel Handles	4.5

## Stitch Scissors

Veterinary Use Only



Unit mm

Code	Products Name	L	U.P.\$
900004	Stitch Scissors	105mm	61.3

## Eye Scissors

Veterinary Use Only



Unit mm

Code	Products Name	Specification	L	U.P.\$
900005	Eye Scissors	Straight	95mm	45.2
900006	Eye Scissors	Curved	95mm	45.2

## Harms Tying Forceps

Veterinary Use Only



Unit mm

Code	Products Name	Specification	L	U.P.\$
900007	Harms Tying Forceps	Straight	100mm	61.3
900007b	Harms Tying Forceps	Curved	100mm	61.3

## Bishop-Harmon Forceps

Veterinary Use Only



Unit mm

Code	Products Name	Specification	L	U.P.\$
900008	Bishop-Harmon Tissue Forceps	1X2 Teeth	85mm	77.4
900009	Bishop-Harmon Serrated Forceps		85mm	77.4

## Capsulorhexis Tweezers

Veterinary Use Only



Unit mm

Code	Products Name	Specification	L	U.P.\$
900028	Capsulorhexis Tweezers	Curved	100mm	77.4

## Westcott Tenotomy Scissors

Veterinary Use Only



Unit mm

Code	Products Name	Specification	L	U.P.\$
900010	Westcott Tenotomy Scissors	Medium Blades Curved	110mm	93.5

## Castroviejo Corneoscleral Scissors

Veterinary Use Only



Unit mm

Code	Products Name	Specification	U.P.\$
900011	Castroviejo Corneoscleral Scissors	Medium Blades Curved Right	109.7
900012	Castroviejo Corneoscleral Scissors	Medium Blades Curved Left	109.7

### Castroviejo Needle Holder

Veterinary Use Only



Unit mm

Code	Products Name	U.P.\$
900013	Castroviejo Needle Holder	141.9

### Castroviejo Eye Speculum

Veterinary Use Only



Unit mm

Code	Products Name	Specification	U.P.\$
900014	Castroviejo Eye Speculum	Small	109.7

### Barraquer Wire Eyelid Speculum

Veterinary Use Only



Unit mm

Code	Products Name	Specification	L	U.P.\$
900015	Barraquer Wire Eyelid Speculum	Small	10mm	9
900016	Barraquer Wire Eyelid Speculum	Large	14mm	9

### Desmarres Chalazion Forceps

Veterinary Use Only



Unit mm

Code	Products Name	Width	L	U.P.\$
900017	Desmarres Chalazion Forceps	16mm	90mm	77.4

## Graefe Fixation Forceps

Veterinary Use Only



Unit mm

Code	Products Name	L	U.P.\$
900018	Graefe Fixation Forceps	115mm	61.3

## Conjunctival scissors

Veterinary Use Only



Unit mm

Code	Products Name	Specification	L	U.P.\$
900019	Conjunctival scissors	Curved	8.5mm	61.3

## Titanium Bishop-Harmon Forceps

Veterinary Use Only



Unit mm

Code	Products Name	Specification	Head Width	L	U.P.\$
900020	Titanium Bishop-Harmon Forceps	Serrated	0.8mm	110mm	61.3
900021	Titanium Bishop-Harmon Forceps	1/2 Teeth	0.25mm	110mm	61.3

## Titanium Needle Holder

Veterinary Use Only



Unit mm

Code	Products Name	Specification	L	U.P.\$
900022	Titanium Needle Holder	Curved	125mm	77.4

## Titanium Eye Scissors

Veterinary Use Only



Unit mm

Code	Products Name	U.P.\$
900023	Titanium Eye Scissors	77.4

## Titanium Barraquer Wire Eyelid Speculum

Veterinary Use Only



Unit mm

Code	Products Name	L	U.P.\$
900024	Titanium Barraquer Wire Eyelid Speculum-A	45mm	9
900025	Titanium Barraquer Wire Eyelid Speculum-B	45mm	18.1

## Sterilization Container

Veterinary Use Only

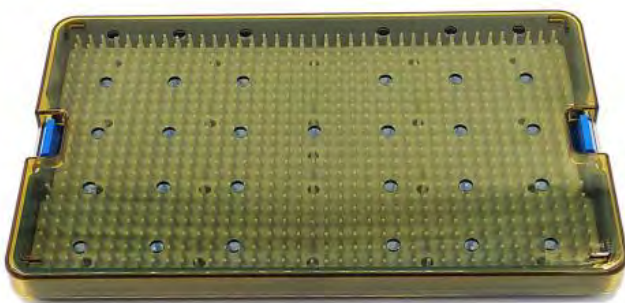

Unit mm

Code	Products Name	Specification	U.P.\$
900026	Sterilization Container	265mmX160mmX22mm	206.5

# Small Animal Ophthalmology Instruments



## Small Animal Ophthalmology Instruments

Code	Products Name/Specification	Quantity
910001	Small Animal Ophthalmology Instruments	
900020	Tanium Bishop-Harmon Forceps-Serrated Head Width 8mm L 110mm	1
900021	Tanium Bishop-Harmon Forceps-1/2 Teeth Head Width 2.5mm L 110mm	1
900005	Eye Scissors Straight 100mm	1
900006	Eye Scissors Curved 100mm	1
900019	Conjunctival Scissors	1
900022	Titanium Needle Holder Curved 125mm	1
900023	Titanium Eye Scissors Curved 125mm	1
900024	Titanium Barraquer Wire Eyelid Speculum-A	1
900025	Titanium Barraquer Wire Eyelid Speculum-B	1
900001	Halstead mosquito Forceps Straight L 125mm	1
900002	Halstead mosquito Forceps Curved L 125mm	1
900026	Sterilization Case	1

U.P.\$	684.7
--------	-------

# Small Animal Ophthalmology Instruments



## Small Animal Ophthalmology Instruments

Code	Products Name/Specification	Quantity
910002	Small Animal Ophthalmology Instruments	
900008	Bishop-Harmon Tissue Forceps 1X2 Teeth 85mm	1
900009	Bishop-Harmon Dressing Forceps, rris-cross serrated tips 85mm	1
900007	Harms Tying Forceps Straight 100mm	1
900007b	Harms Tying Forceps Curved 100mm	1
900010	Westcott Tenotomy Scissors Medium Blades Curved	1
900011	Castroviejo Corneoscleral Scissors right Medium Blades Curved Right	1
900012	Castroviejo Corneoscleral Scissors left Medium Blades Curved Left	1
900013	Castroviejo Needle Holder Curved With Lock	1
900005	Eye Scissors Straight 95mm	1
900006	Eye Scissors Curved 95mm	1
900004	Stitch Scissors Curved 105mm	1
900014	Castroviejo Eye Speculum Small	1
900015	Barraquer Wire Eyelid Speculum Small 10mm	1
900016	Barraquer Wire Eyelid Speculum Large 14mm	1
500036	Standard NO-3 Scalpel Handles	1
900001	Halstead Mosquito Forceps Straight 100mm	1
900002	Halstead Mosquito Forceps 100mm Curved	1
900017	Desmarres Chalazion Forceps Width 16mm L 90mm	1
900018	Graefe Fixation Forceps 115mm	1
200003	Sterilization Container	1

U.P.\$	1267.1
--------	--------

# Sterilization Box

## Sterilization Box

Veterinary Use Only

Unit mm



Code	Products Name	Specification	U.P.\$
200003	Sterilization Box(Red)	275X165X50mm	90.3
2000031	Sterilization Box(Green)	275X165X50mm	90.3
2000032	Sterilization Box(Golden)	275X165X50mm	90.3
2000033	Sterilization Box(Blue)	275X165X50mm	90.3

## Sterilization Box

Veterinary Use Only

Unit mm



Code	Products Name	Specification	U.P.\$
200001	Sterilization Box	250X200X50mm	90.3

## Instruments Sterilization Basket

Veterinary Use Only

Unit mm



Code	Products Name	Specification	U.P.\$
200005	Instruments Sterilization Basket	265X120X70mm	72



Sterilization Box

Veterinary Use Only

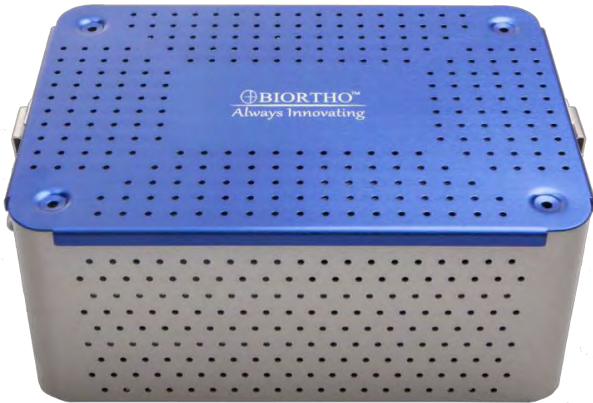

Unit mm

Code	Products Name	Specification	U.P.\$
200002	Sterilization Box	350X250X150mm	206.5



Sterilization Box

Veterinary Use Only

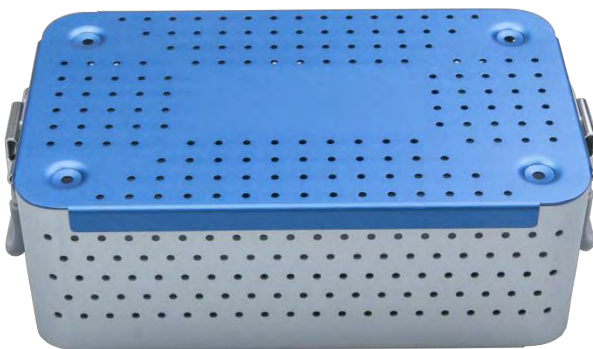

Unit mm

Code	Products Name	Specification	U.P.\$
200004	Sterilization Box	300X180X105mm	190.3



# Anaesthesia

## Small Animals Laryngoscope

Veterinary Use Only

Unit mm



Code	Products Name	Specification	U.P.\$
M1001	Small Animals Laryngoscope	Set	161.3
	Laryngoscope Handle		
	Laryngoscope Head With LED	80mm	
	Laryngoscope Head With LED	105mm	
	Laryngoscope Head With LED	155mm	
	Laryngoscope Head With LED	195mm	



## Anaesthetic Intubation Guide Wire

Veterinary Use Only

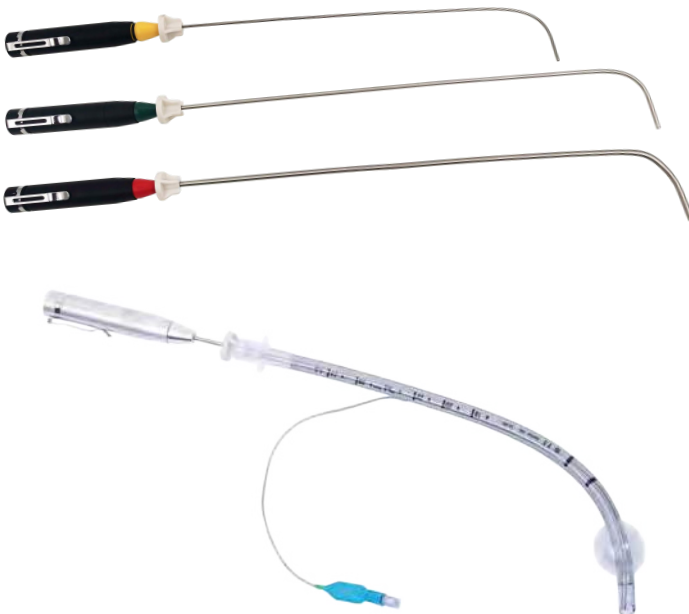

Code	Products Name	U.P.\$
M1002S	Anaesthetic Intubation Guide Wire	90.3
M1002M	Anaesthetic Intubation Guide Wire	90.3
M1002L	Anaesthetic Intubation Guide Wire	90.3



## Endotracheal Tube

Veterinary Use Only

Unit mm



Code	Inside Dia	U.P.\$
C100325	2.5mm	2.9
C100330	3.0mm	2.9
C100335	3.5mm	2.9
C100340	4.0mm	2.9
C100345	4.5mm	2.9
C100350	5.0mm	2.9
C100355	5.5mm	2.9
C100360	6.0mm	2.9

Code	Inside Dia	U.P.\$
C100365	6.5mm	2.9
C100370	7.0mm	2.9
C100375	7.5mm	2.9
C100380	8.0mm	2.9
C100385	8.5mm	2.9
C100390	9.0mm	2.9
C100395	9.5mm	2.9
C1003100	10.0mm	2.9

## Reinforced Endotracheal Tube

Veterinary Use Only

Unit mm



Code	Inside Dia	U.P.\$
C100425	2.5mm	7.7
C100430	3.0mm	7.7
C100435	3.5mm	7.7
C100440	4.0mm	7.7
C100445	4.5mm	7.7
C100450	5.0mm	7.7
C100455	5.5mm	7.7
C100460	6.0mm	7.7

Code	Inside Dia	U.P.\$
C100465	6.5mm	7.7
C100470	7.0mm	7.7
C100475	7.5mm	7.7
C100480	8.0mm	7.7
C100485	8.5mm	7.7
C100490	9.0mm	7.7
C100495	9.5mm	7.7
C1004100	10.0mm	7.7

## Silicone Foley Catheter

Veterinary Use Only

Unit mm



Code	Soecification	Gasbag	L	U.P.\$
C100306	6Fr	3ml	320mm	7.7
C100308	8Fr	3/5ml	320mm	7.7
C100310	10Fr	3/5ml	320mm	7.7

# Warmology AIR WARM SYSTEM

Veterinary Warming System

Veterinary Use Only



Code	Products Name	U.P.\$
C10040	Veterinary Warming System	1612.6
C10041	Sterilized Warming Air Blanket Small	3.9
C10042	Sterilized Warming Air Blanket Medium	4.8
C10043	Sterilized Warming Air Blanket Large	7.1
C10044	Washable Warming Air Blanket	128.7

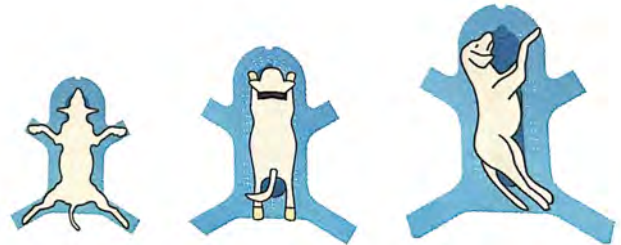

The main heating unit offers a multitude of beneficial functions and features

1. The operating noise level is very low. (53DBA).
2. Three tiered sterilization system, 254nm ultra violet light, high concentration negative ion and 0.2µm HEPA filtering.
3. Dual detecting temperature control with 1.5 Celsius degree minus tolerance ensured. Two sensors are located at the out let from the heat unit also at the end of the hose, detecting and compensating for heat loss from the hose.
4. Adjustable wind speed (two stages) with stable temperature control.
5. Easy to handle and maintain, smart trouble shooting system installed.
6. Accurate LCD display, real time temperature of blanket monitoring.
7. The unit can be freestanding or easily attached to our specialized stand.
8. Compact and light weighted, using little space, easy to transport
9. Four stage temperature settings, 93F(34C°), 98F(37C°), 104F° (40C°), 109 F° (43C°).
10. Swivelling easy to fit outlet port, makes attaching the hose effortless.

The system could be used before, during and after surgical or dentistry operations.

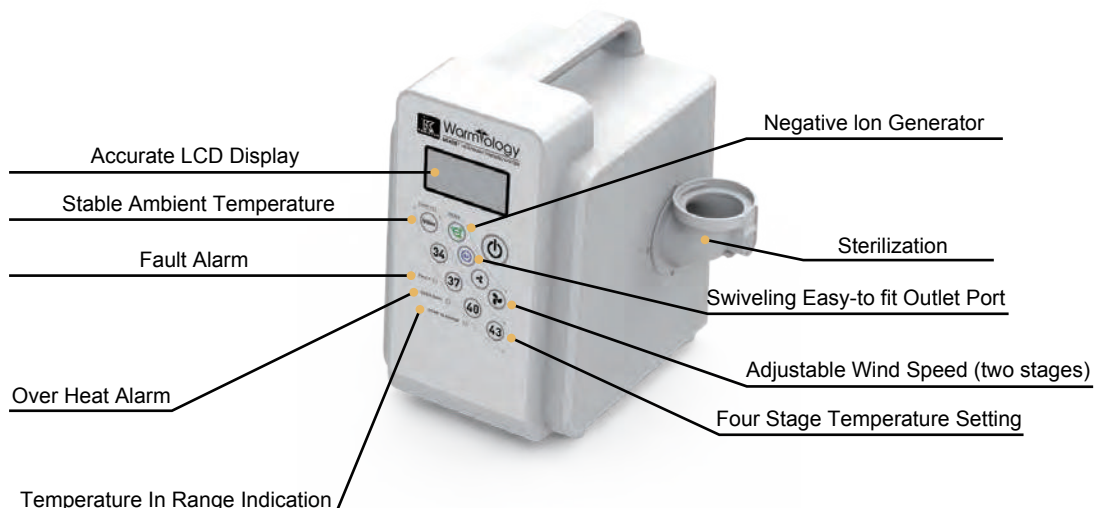

## Absorb Sutures

Veterinary Use Only

Unit mm



Code	U.S.P	Needle Specification	Wire Rod	L	U.P.\$
S03610	0	Stainless Steel 36mm 1/2 Circle	PGA Absorbable Wire	750mm	25.8
S02820	2-0	Stainless Steel 28mm 1/2 Circle	PGA Absorbable Wire	750mm	25.8
S02530	3-0	Stainless Steel 25mm 1/2 Circle	PGA Absorbable Wire	750mm	25.8
S02440	4-0	Stainless Steel 24mm 1/2 Circle	PGA Absorbable Wire	750mm	25.8

Code	U.S.P	Needle Specification	Wire Rod	L	U.P.\$
S14410	0	Stainless Steel 44mm 3/8 Angle	PGA Absorbable Wire	750mm	25.8
S12820	2-0	Stainless Steel 28mm 3/8 Angle	PGA Absorbable Wire	750mm	25.8
S12530	3-0	Stainless Steel 25mm 3/8 Angle	PGA Absorbable Wire	750mm	25.8
S12440	4-0	Stainless Steel 24mm 3/8 Angle	PGA Absorbable Wire	750mm	25.8



## Surgical Blade

Veterinary Use Only



Code	Products Name	Specification	Scalpel Handles	U.P.\$
SB0310	Disposable Surgical blade	NO.10	NO.3	11
SB0311	Disposable Surgical blade	NO.11	NO.3	11
SB0423	Disposable Surgical blade	NO.23	NO.4	11



# BIORTHO CO LTD



**ADD: Add:Building E,No.15,Guotai North  
Road,Zhangjiagang,Jiangsu,China.215600**

**TEL : 0512-82550025**

**FAX : 0512-82550425**

**EMAIL : vet@biortho.cn**

**www.veterinaryorthopedic.com**

**Whatsapp +86 15162363967**